

TABLE OF CONTENTS

Opening - Short Form	1
Reception of Inspecting Officer	6
Reception of Distinguished Guests	20
Flag Presentation	29
Full Form Opening	34
Reception of Commander	34
Communicate Across the Lines	48
Inspection and Review	52
Pass in Review	64
Triangle	68
Alternate Triangle	81
Rehearsal of Duties	86
Close the Commandery	94

KEY

OFFICERS

- Commander ① 1
- Generalissimo ② 2
- Captain General ③ 3
- Senior Warden ④ 4
- Junior Warden ⑤ 5
- Prelate ⑥ 6
- Standard Bearer ⑦ 7
- Sword Bearer ⑧ 8
- Warder ⑨ 9
- Sentinel ⑩ 10
- Sir Knights ○ ●
- Inspecting Officer/ Guest □ ■
- Grand Warder ◆
- Flag ☆ ★

Inspection of Constituent Commandery

OPENING - SHORT FORM

COMM: Officers - Take your stations, Sir Knights, be seated.

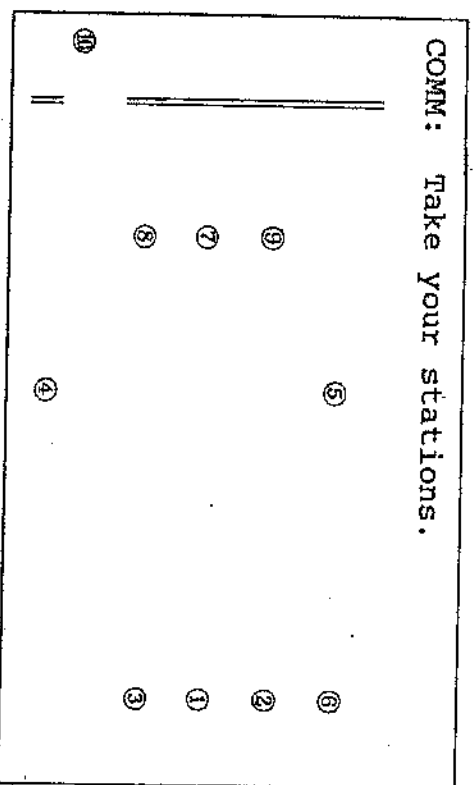

COMM: Sir Knight Senior Warden: - Are all present Knights Templar? (Examination made as in Full Form.)

SR WARD: (Sword salute) Eminent Commander: - All present are Knights Templar.

COMM: Sir Knight Warden: (Warder rises, takes one step forward, draws sword, Sword Salutes) - Post the Sentinel, inform him that _____ Commandery No. _____ is about to be opened

and direct him to guard accordingly. (After the order is given, the Commander will return the salute, releasing the Warder. The Warder goes to the door, opens the door, and informs the Sentinel as follows:.)

COMM: Post the Sentinel.

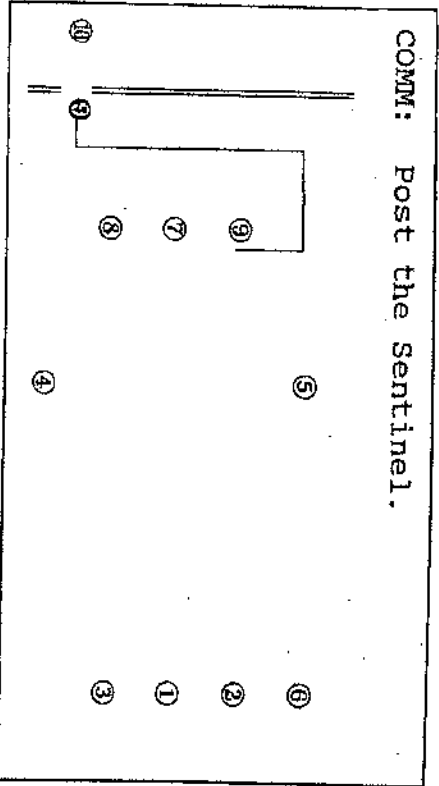

WARDER: Sir Knight Sentinel: - _____ Commandery
No. _____ is about to be opened and you are directed to guard accordingly.

SENT: It shall be done.

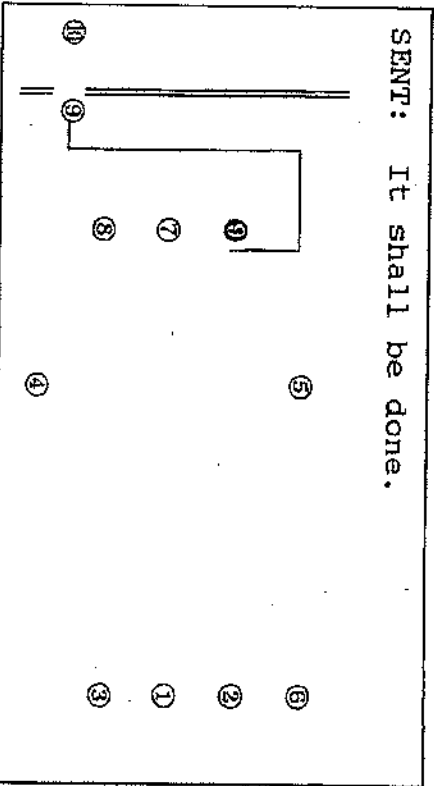

SENT:

Sir Knight Warder: - It shall be done.
(Warder closes door, gives knocks xxx xxx xxx x, which is answered by the Sentinel. Warder returns to his station and reports.)

WARDER:

(Sword Salutes) Eminent Commander: The Sentinel is at his post and the Asylum is duly guarded. (Eminent Commander returns the salute, Warder returns sword.)

COMM:

(Rising) Sir Knights: - Attention. Uncover. Excellent Prelate: - Lead our devotions. (Prelate gives prayer ending with the Lord's Prayer.)

COMM:

Sir Knights: - Recover. Waiving further ceremony, I now declare _____ Commandery No. _____ opened for the dispatch of such business as may regularly come before it, requiring all Knights present to govern themselves according to the sublime principles of this magnanimous order.

COMM:

Sir Knight Warder: - Inform the Sentinel and direct him to guard accordingly. (Warder Sword Salutes the Commander, goes to the door and reports.)

COMM: Inform the Sentinel.

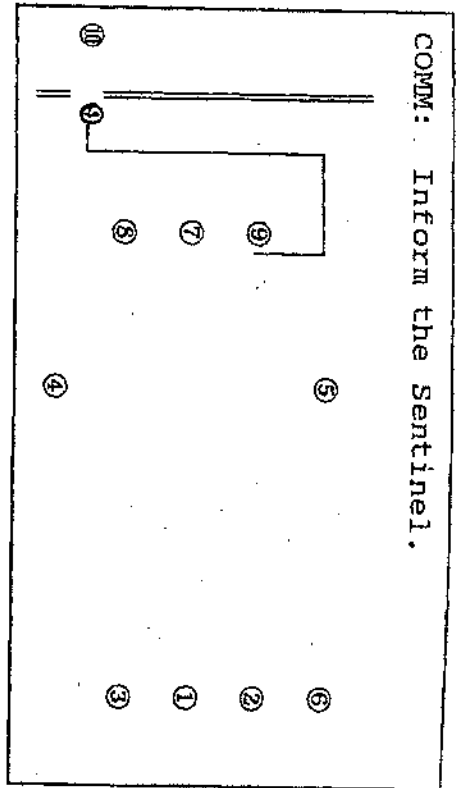

WARDER: (Opens door and says) Sir Knight Sentinel: -

The Commandery is now open. Take due notice and guard accordingly. (Warder closes door, gives knocks xxx xxx xxx x, answered by the Sentinel. Warder resumes station and reports.)

WARD: (warder class door, gives knocks ...)

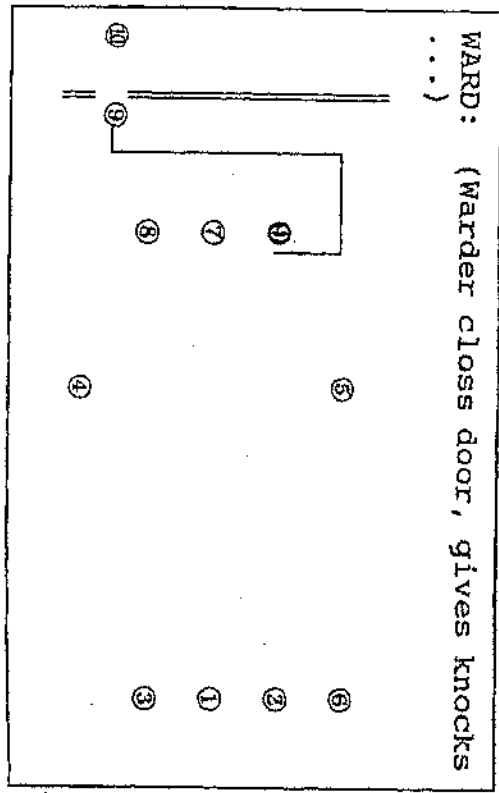

WARDER:

(Sword Salutes the Commander) Eminent Commander: - Your order has been obeyed. (The Commander returns the salute.)

COMM:

Sir Knights: - Be seated.

Reception of Inspecting Officer

The Grand Warder for the inspecting officer will instruct the Sentinel to give the proper battery on the door of the Asylum (xxx xxx xxx x).

WARDER: (Immediately upon hearing the alarm, the Warder will rise, draw sword, salute the Commander and report.)

WARDER: Eminent Commander: - There is an alarm.

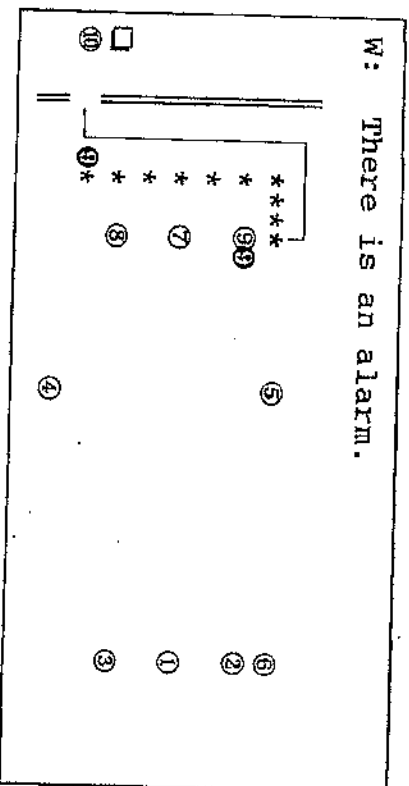

COMM: Sir Knight Warder: - Attend to the alarm. (Commander returns the salute thus releasing the Warder who goes to the door, gives battery, xxx xxx xxx x. The door is opened by the Sentinel and his report made.)

WARDER: Sir Knight Sentinel: - What is the cause of the alarm?

SENT: Sir Knight Warder: - The Grand Warder for

NAME AND TITLE desires admission. (The Warden returns to his station, salutes the Commander and reports.)

WARDER: Eminent Commander: - The alarm was caused by Sir Knight Sentinel who reports that the Grand Warden for NAME AND TITLE desires admission.

COMM: Permit him to enter. (Commander answers the salute thus releasing the Warden who goes to the door, opens it without knocking and reports.)

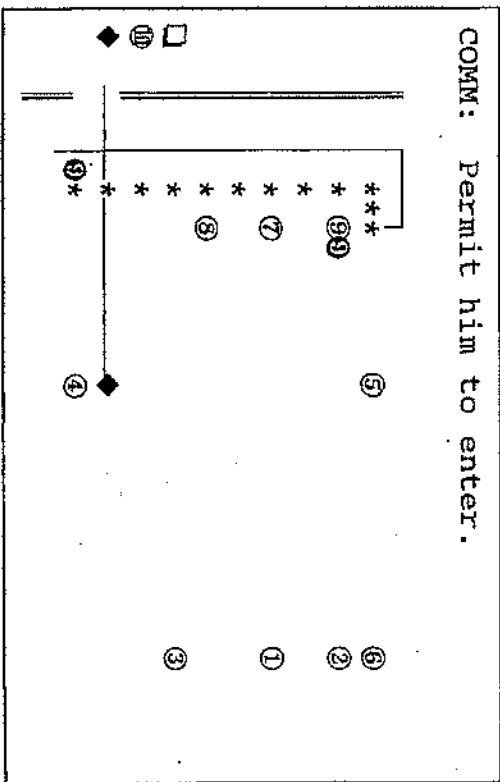

WARDER: The Commander permits him to enter. (As the Grand Warden enters, the Warden will announce:) - The Grand Warden for NAME AND TITLE approaches. (The Warden will sword salute the Grand Warden, come to carry swords after he has passed, remain at

the door until the Grand Warden retires, again saluting him as he retires, comes to carry swords and returns to his station.)

GR WARD: (Sword Salutes) Eminent Commander: I am directed to report that NAME AND TITLE, representing the Grand Commander, is in waiting to inspect your commandery.

COMM: Eminent Grand Warden: - Inform NAME AND TITLE that the lines will be formed and an escort will immediately wait upon him. (The Commander will now salute the Grand Warden thus releasing him. The Grand Warden retires and reports.)

GR WARD: (Sword Salutes) The Eminent Commander of _____ Commandery No. ___ directs me to inform you that the lines will be formed and an escort will immediately wait upon you.

COMM: Sir Knight Captain General: - (The Captain General rises, draws sword and sword salutes the Commander.) Form the lines for the reception of NAME AND TITLE. (The Commander then returns the salute, thus releasing the Captain General.)

CAP GEN: Sir Knight Senior Warden: - (Senior Warden rises, faces the Captain General, draws sword and sword salutes.) Form the lines for the reception of NAME AND TITLE. (Captain General returns the sword salute

thus releasing the Senior Warden.)

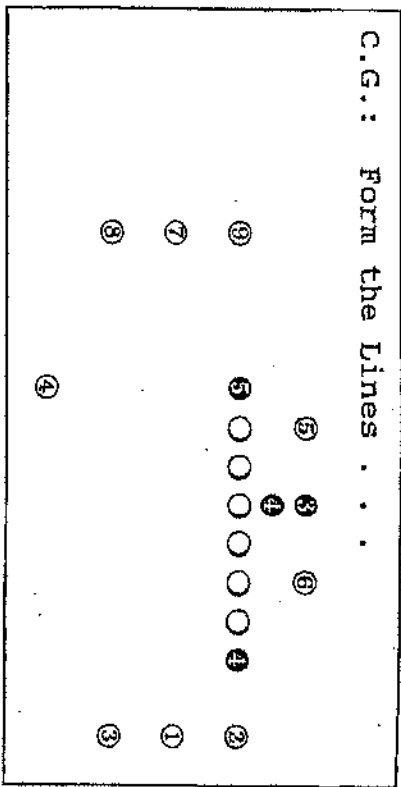

SR WARD: (The Senior Warden leaves his station on the south side of the Asylum, moves the shortest distance to the East of the Asylum, stopping in front of the Generalissimo's station on the Asylum floor. He faces west and commands:)

SR WARD: 1. Commandery, 2. Attention, 3. Fall-in. (At the command "Fall-in", all not excused, without drawing swords, promptly fall-in, single file, facing east, dressing on the Senior Warden, graduated in size from front to rear. The Junior Warden falls in on the west end or bottom of the line.)

CAP GEN: All Sir Knights on the side lines be seated. (All officers remaining standing except the Recorder and the Prelate. The Captain General takes his station on the north side of

the Asylum, six or eight paces from and in the center of the line, facing the line. After the Captain General has taken his position, the Senior Warden takes his position on the north side of the Asylum about three paces in front and center of the line, facing the line.)

SR WARD: 1. Left, 2. Face, 3. Draw, 4. Swords, (including the Standard Guard) 5. Count, 6. Twos. (The Senior Warden dresses the line, returns to his station in front of the line, and commands:) 1. Present, 2. Swords. (The Senior Warden faces about, sword salutes the Captain General and reports.)

SR WARD: Sir Knight Captain General. - The lines are formed. (The Captain General returns the salute, releasing the Senior Warden. The Senior Warden takes his station without command as right guide by the shortest route.)

CAP GEN: 1. Carry, 2. Swords, 3. Open ranks.

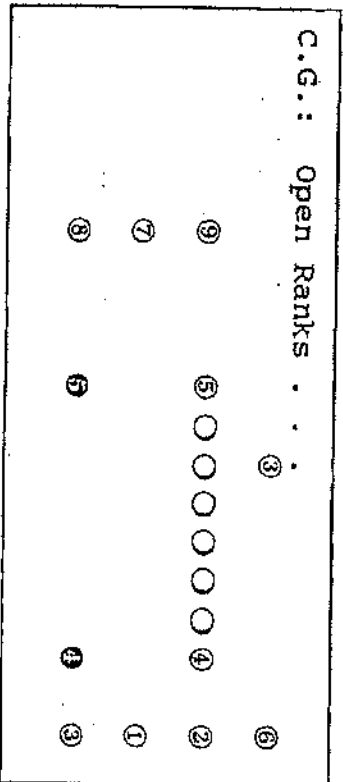

(The Senior and Junior Wardens step back to just in front of the Captain General's station on the dais to mark the new alignment of the rear rank. The Captain General goes to the right flank to see that the Wardens are in line parallel to the front rank. He then places himself, facing the left, three paces in front of the line and commands:)

CAP GEN: March.

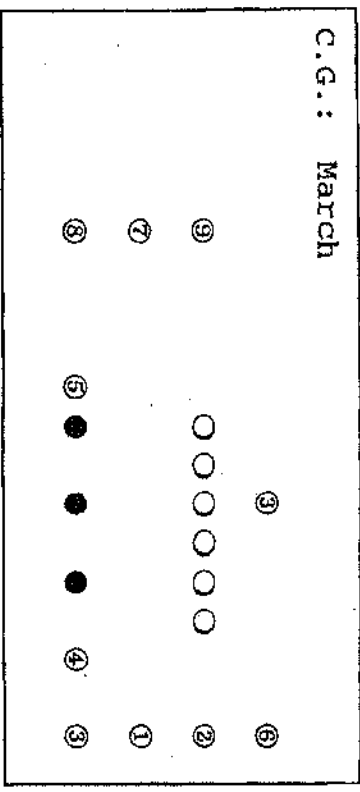

(The front rank, the odd numbered knights, will dress to the right without closing interval; the even numbered knights who constitute the rear rank, cast their eyes to the right, step backwards, halt a little in the rear of the alignment, then dress to the right without closing intervals on the line established by the Wardens. The Captain General superintends the alignment of the front and rear ranks, then places himself, facing the left, three paces in front

of the front rank and commands:)

CAP GEN: Front. (The Wardens resume their places in the front rank and the Sir Knights cast their eyes to the front.)

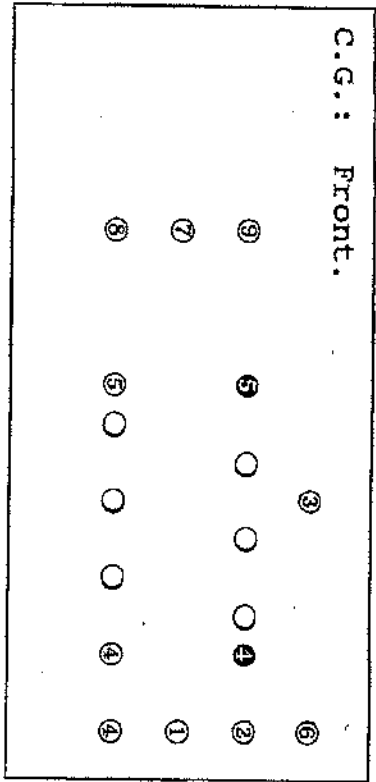

CAP GEN: 1. Form two divisions, 2. Files, 3. Cover,

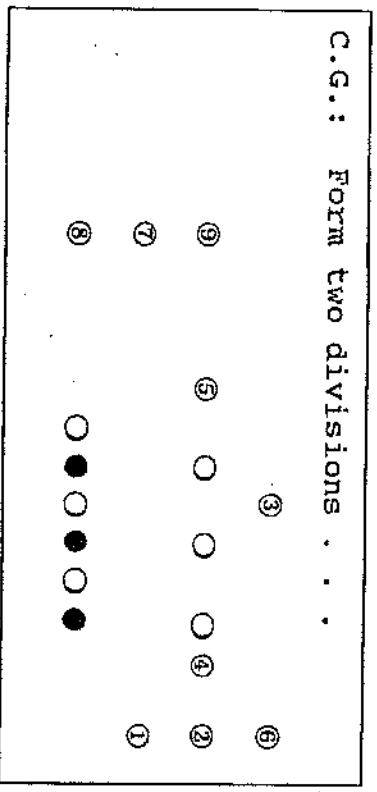

(At the command "Cover", the rear rank takes two right steps (ten inch, step) and cover on the front rank and becomes the first division.)

CAP GEN: Front rank: - About, 2. Face. (At the command "Face", the front rank faces about becomes the second division. The Senior Warden will about face with the front rank, and without command, take his place on the left of the first division, opposite the Junior Warden. The Senior Warden will march forward one pace beyond the first division, right face and march to the left of the first division. The Captain General will now take his place on the dais in the east.)

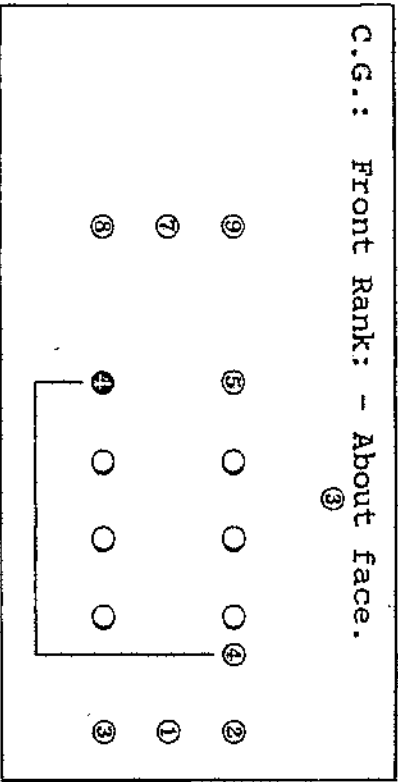

CAP GEN: Sir Knight Junior Warden: - (The Junior Warden steps forward to the center of the lines, faces east and sword salutes the Captain General.)

CAP GEN: Be in readiness to march the Standard Guard as escort to the apartment of NAME AND TITLE. (The Captain General returns the Junior Warden's salute thus releasing him. The Junior Warden faces about, steps

forward to the Standard Guard, and commands:)

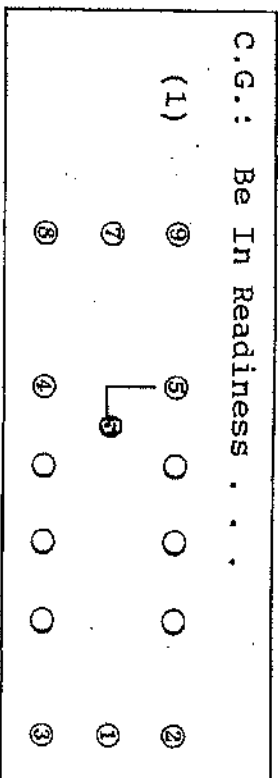

JR WARD: Standard Guard as escort: - 1. Right 2. Face. (Junior Warden takes station in front of the Standard Guard facing south.)

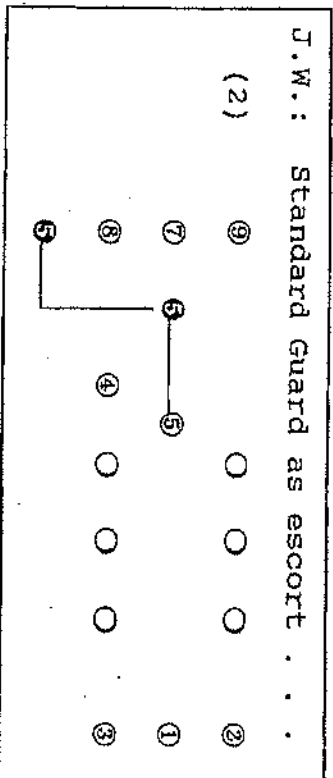

CAP GEN: (Sword salute) Eminent Commander: - The lines are formed and the escort is in readiness.

COMM: Sir Knight Generalissimo: - (Hand salute) With the Standard Guard as escort, you will repair to the apartment of NAME AND TITLE and inform him the lines are formed

for his reception. (The Generalissimo hand salutes the Commander, passes north of the lines to the escort, and takes his place in the rear of the escort.)

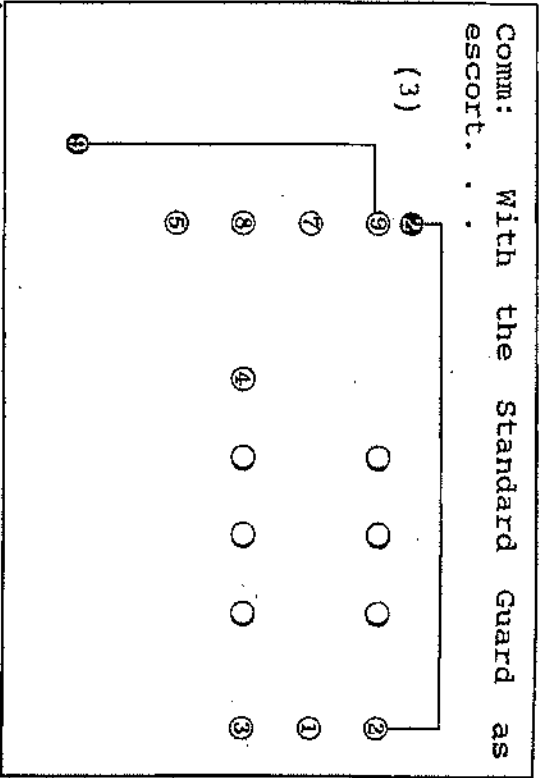

GEN: Sir Knight Junior Warden: - Carry on.

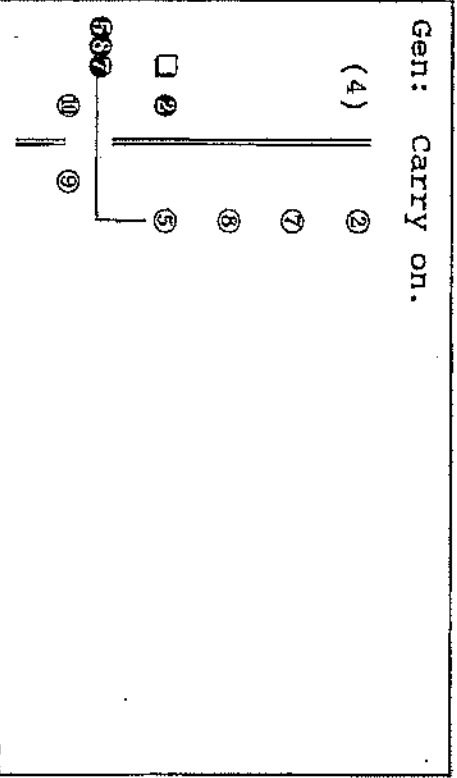

JR WARD:

1. Escort, 2. Forward, 3. March, 4. Column right, 5. March. (When the Generalissimo approaches the Standard Guard, the Warden will leave his station at the rear of the Standard Guard and take station at the door of the Asylum on the south side. He will open the door for the escort to pass out. After he has opened the door, he will step back into the Asylum and sword salute the escort as it passes out the Asylum door. He will remain at the door until the escort and Grand Inspecting Officer approach. Whereupon he will Sword Salute and give the NAME AND TITLE of the Grand Officer approaching. After the escort has passed, the Warden will return to his station at the left of the Standard Guard and come to present swords. The Junior Warden conducts the escort to the apartment of the Grand Officer and commands:)

JR WARD:

1. Escort, 2. Halt, 3. Left or right face (as the case may be) 4. Present, 5. Swords. (The Junior Warden sword salutes the Grand Officer.)

GEN:

(Hand salutes the Grand Officer) NAME AND TITLE. I have the honor to inform you that the lines are formed and the escort awaits your pleasure.

GR OFF:

(Returns the Generalissimo's salute with his hand and says) Sir Knight Generalissimo: -

It is my pleasure to be escorted into the Asylum.

GEN: Sir Knight Junior Warden: - Carry on. (As the Grand Officer is escorted into the Asylum, the Generalissimo will step to the left side of the Grand Officer to escort him into the Asylum.)

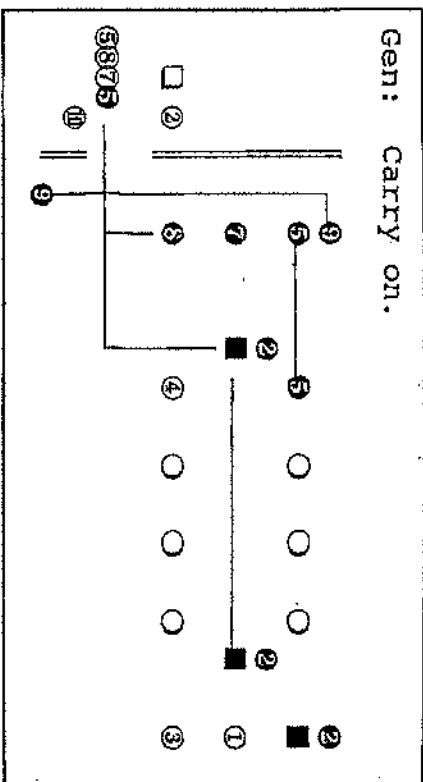

JR WARD: 1. Escort, 2. Carry, 3. Swords, 4. Left or right face (as the case may be) 5. Forward, 6. March. (After the command "face", the Junior Warden will take his place on the opposite end of the line and the Standard Guard will return to the Asylum in reverse order. As the escort approaches the Asylum door, the Warden will sword salute and announce:) NAME AND TITLE approaches.

CAP GEN: 1. Commandery, 2. Attention.

JR WARD: (The Junior Warden will march the escort to their stations in the west and commands:) 1. Escort, 2. HALT, 3. Right, 4. Face, 5. Present, 6. Swords. (The Junior Warden takes his station on the right of the second division facing the Senior Warden.)

CAP GEN: (After the Junior Warden has taken his station, the Captain General will command:) 1. Form Arch of Steel, 2. Cross, 3. Swords. (After the commands are given and executed, the Generalissimo and the Grand Officer will pass through the lines. The Grand Officer alone will uncover. When they have passed through the lines and have reached the east, the Captain General will command:) 1. Carry, 2. Swords. (The Sir Knights on the side lines will uncover at command "Form Arch of Steel" and remain so until the command "Carry Swords".)

NOTE: Only the INSPECTING OFFICER, GRAND COMMANDER, PAST GRAND COMMANDERS, THE GRAND MASTER OF THE GRAND ENCAMPMENT, HIS REPRESENTATIVES AND PAST GRAND MASTERS are entitled to be received under an Arch of Steel.

GEN: (After the Generalissimo and the Inspecting Officer, or the Grand Commander, have reached the east after passing through the lines, the Generalissimo will hand salute the Commander and report.) Eminent

Commander: - I have the honor to present
Sir Knight NAME AND TITLE.

COMM: (Hand salutes the Inspecting Officer.) It gives me pleasure to welcome you to our Asylum. I now surrender to you my chair of office and ask you to preside over this conclave. (The Inspecting Officer will return the salute, acknowledge the courtesy, and return the authority to the Commander.)

RECEPTION OF DISTINGUISHED GUESTS

The Grand Warder for the distinguished guests will instruct the Sentinel to give the proper battery on the door of the Asylum (xxx xxx xxx x).

WARDER: (Sword Salute) Eminent Commander: -
There is an alarm.

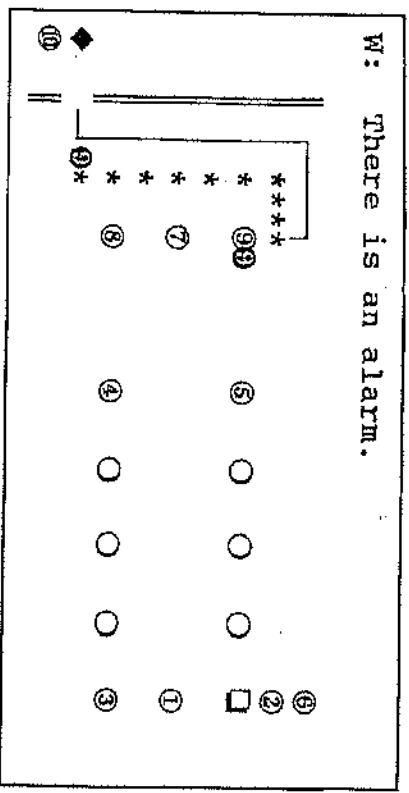

COMM: Sir Knight Warder: - Ascertain the cause of the alarm. (Warder goes to the door, gives battery, Sentinel opens the door.)

WARDER: Sir Knight Sentinel: - What is the cause of the alarm?

SENT: Sir Knight Warder: - The Grand Warder for NAME AND TITLE desires admission.

WARDER: (Returns to his station, Sword Salutes the Commander and reports.) Eminent Commander: - The alarm was caused by Sir

Knight Sentinel who reports that the Grand Warden for NAME AND TITLE desires admission.

COMM: Permit him to enter. (Commander returns salute, thus releasing the Warden. The Warden goes to the door and opens it without battery.)

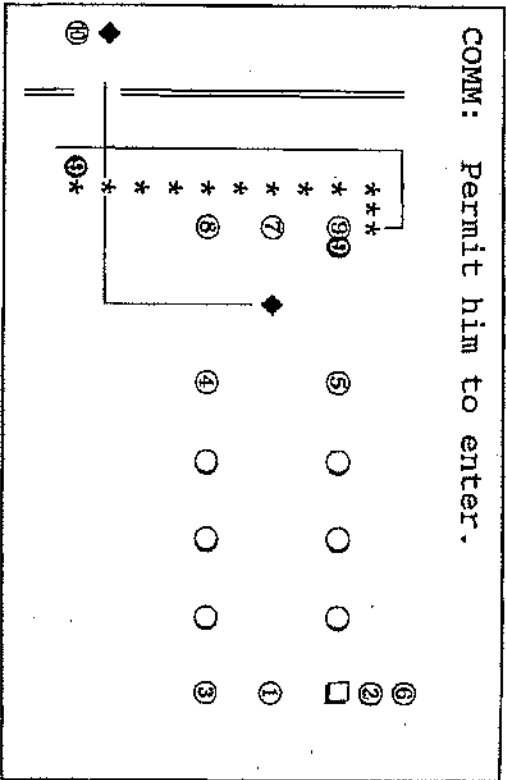

WARDER: Sir Knight Sentinel: - The Eminent Commander permits him to enter. (Warden remains at the door, sword salutes and announces:) The Grand Warden for NAME AND TITLE approaches.

GR WARD: (Sword Salutes) Eminent Commander: - I am directed to report that Sir Knight NAME AND TITLE (and his staff- if applicable) are in waiting to visit your commandery.

COMM: Eminent Grand Warden: - Inform Sir Knight NAME AND TITLE, that the lines are formed and an escort will immediately wait upon him. (After the Commander has made his report to the Grand Warden, he will hand salute the Grand Warden, thus releasing him.)

COMM: Sir Knight Junior Warden: - (The Junior Warden steps to the center of the lines, faces the east, Sword Salutes the Commander.) Be in readiness to march the Standard Guard as escort to the apartment of NAME AND TITLE. (The Commander hand salutes the Junior Warden, thus releasing him.)

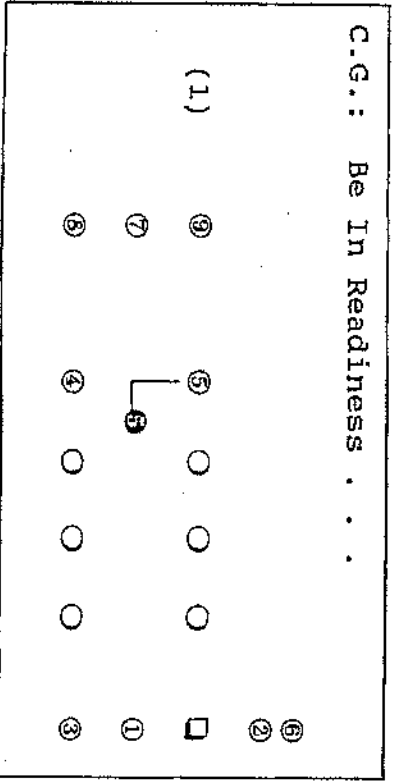

JR WARD: (The Junior Warden about faces, goes to the Standard Guard and commands:) Standard Guard as escort: - 1. Right, 2. Face. (Junior Warden takes station in front of the Standard Guard facing south.)

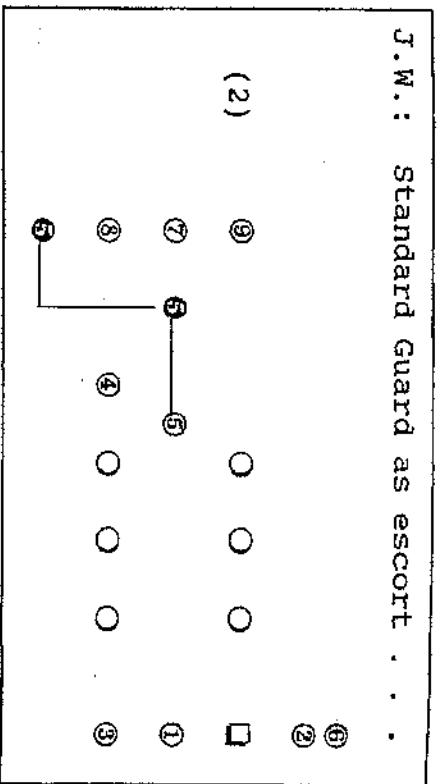

COMM: Sir Knight Generalissimo: - (Hand Salute)
 With the Standard Guard as escort, you will
 repair to the apartment of NAME AND
TITLE and inform him that the lines are
 formed for his reception.

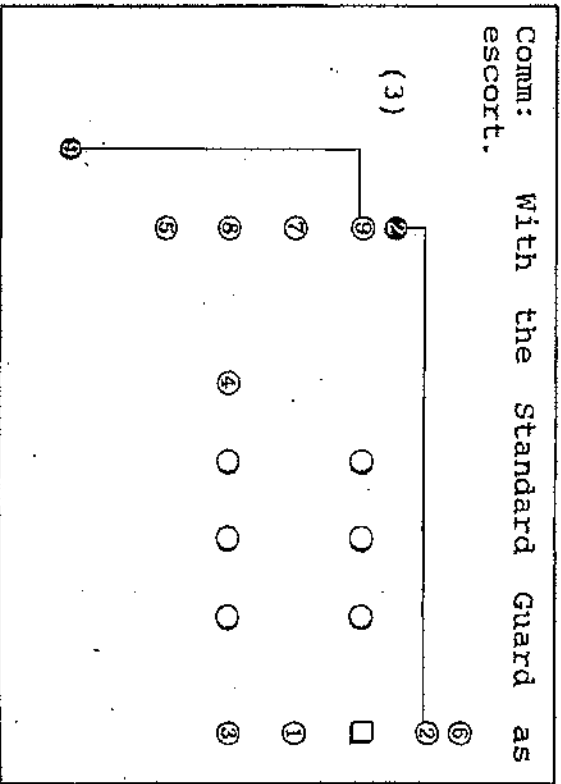

(The Generalissimo hand salutes the
 Commander, passes north of the lines to
 the escort and takes his place at the rear of
 the escort.)

GEN: Sir Knight Junior Warden: - Carry on.

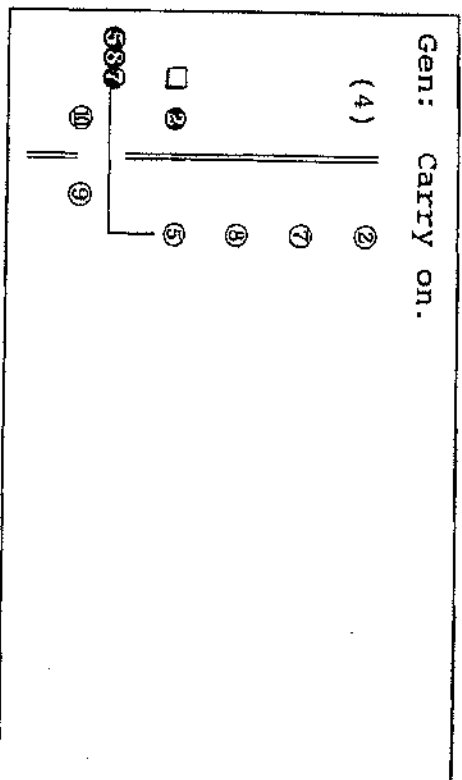

JR WARD: 1. Escort, 2. Forward, 3. March, 4. Column
 right, 5. March. (When Generalissimo
 approaches the Standard Guard, the Warden
 will leave his station at the rear of the
 Standard Guard and take station at the door
 of the Asylum on the south side. He will
 open the door for the escort to pass out.
 After he has opened the door, he will step
 back into the Asylum and sword salute the
 escort as they pass out of the Asylum door.
 He will remain at the door until the escort

and the Grand Officer approach. Where upon he will Sword Salute and give the NAME AND TITLE of the Grand Officer approaching. After the escort has passed, the Warden will return to his station at the left of the Standard Guard and come to present swords. The Junior Warden conducts the escort to the apartment of the Grand Officer and commands:)

JR WARD:

1. Escort, 2. Halt, 3. Left or right face (as the case may be) 4. Present, 5. Swords. (The Junior Warden sword salutes the Grand Officer.)

GEN:

(Hand salutes the Grand Officer) NAME AND TITLE - I have the honor to inform you that the lines are formed and the escort awaits your pleasure.

GR OFF:

(Returns the Generalissimo's salute with his hand and says) Sir Knight Generalissimo: - It is my pleasure to be escorted into the Asylum.

GEN:

Sir Knight Junior Warden: - Carry on. (As the Grand Officer is escorted into the Asylum, the Generalissimo will step to the left side of the Grand Officer to escort him into the Asylum.)

JR WARD:

1. Escort, 2. Carry, 3. Swords, 4. Left or right face (as the case may be) 5. Forward, 6. March. (After the command "face", the

Junior Warden will take his place on the opposite end of the line and the Standard Guard will return to the Asylum in reverse order. As the escort approaches the Asylum door, the Warden will sword salute and announce.)

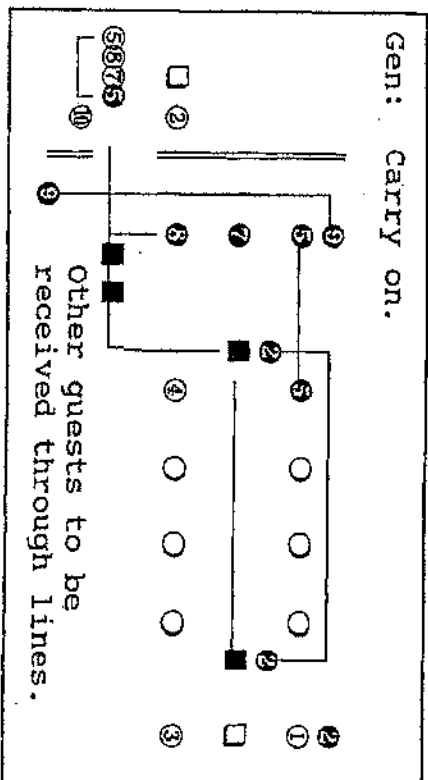

WARDER:

NAME AND TITLE approaches. (After the escort has passed the Warden will return to his station at the left of the Standard Guard and come to present swords.)

CAP GEN:

1. Commandery, 2. Attention.

JR WARD:

(The Junior Warden will march the escort to their stations in the west and commands:) 1. Escort, 2. Halt, 3. Right, 4. Face, 5. Present, 6. Swords. (The Junior Warden takes his station on the right of the second division facing the Senior Warden.)

CAP GEN:

(After the Junior Warden has taken his station, the Captain General will command:)

1. Form Arch of Steel, 2. Cross, 3. Swords.

(After the commands are given and executed, the Generalissimo and the Grand Officer will pass through the lines. The Grand Officer alone will uncover. When they have passed through the lines and have reached the east, the Captain General will command:)

1. Carry, 2. Swords.

NOTE: As the Grand Commander or his Representative, Past Grand Commanders or the Grand Master or his Representatives come through the lines they will be given an arch of steel. All other Grand Officers or guests will be given 1. Present, 2. Swords. Each guest will be escorted through the lines individually.

GEN:

Eminent Commander: - I have the honor to present NAME AND TITLE. (Hand salute)

COMM:

Right Eminent Grand Commander (or other name and title): - It gives me great pleasure to welcome you to our Asylum. Sir Knights, I have the pleasure of presenting to you Sir Knight NAME AND TITLE. (If the guest is the Right Eminent Grand Commander or his representative, he will continue as follows.)
I now surrender to you my chair of office and ask you to preside over this conclave: (The R.E.G.C. will accept the courtesy, introduce his staff if present, make a few remarks and then return authority back to the

Eminent Commander.)

COMM:

Sir Knight Captain General: - (The Captain General sword salutes the Commander.)
Dismiss the lines. (The commander hand salutes the Captain General, thus releasing him to carry out the order.)

CAP GEN:

1. Return, 2. Swords, 3. About, 4. Face, 5. Be Seated.

19
18
17
16
15
14
13
12
11
10
9
8
7
6
5
4
3
2
1

FLAG PRESENTATION

NOTE: The flag may be presented by the Standard Guard or a color guard appointed for the purpose.

COMM: Sir Knight Senior Warden: - (Senior Warden comes to attention, takes one step forward, faces the Commander, draws sword and sword salutes.) Present the United States Colors. (Commander hand salutes the Senior Warden. The Senior Warden comes to carry swords, about faces and proceeds to the right side of the Sword Bearer. At this time the Commander arises, draws his sword and commands:)

COMM: Present the United States Colors.

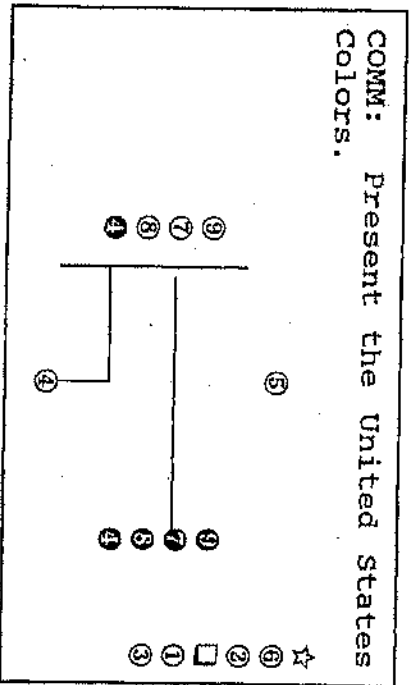

20 COMM: 1. Commandery, 2. Attention, 3.
21 Draw, 4. Swords.
22

1 SR WARD: 1. Standard Guard, 2. Forward, 3.
 2 March. (When about four paces from
 3 the dais he will give the commands.)
 4 1. Standard Guard, 2. Halt, 3. Sir
 5 Knight Standard Bearer, 4. Secure
 6 the flag. (Standard Bearer marches to
 7 three paces of the flag, executes
 8 Sword Salute, comes to carry, returns
 9 sword and hooks scabbard on first
 10 ring.)
 11

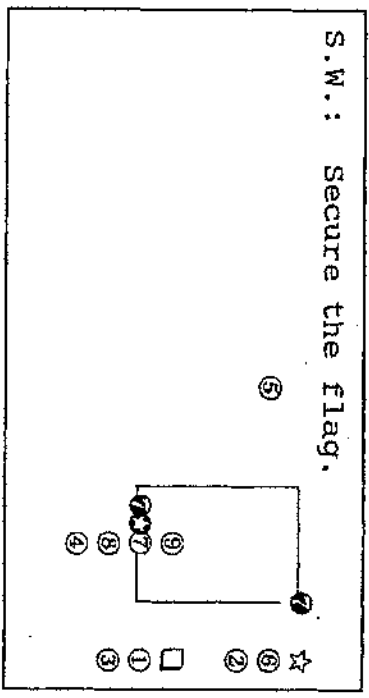

12 COMM: 1. Commandery, 2. Present, 3.
 13 Swords. (OFFICERS ON THE DAIS
 14 WILL EXECUTE SWORD
 15 SALUTE. The Standard Bearer
 16 secures flag, marches around the
 17 north end of the Standard Guard to
 18 his place in the line
 19
 20 SR WARD: 1. Standard Guard, 2. Carry, 3.
 21 Swords, 4. Right Wheel, 5. March.
 22 (They will march around the
 23 Asylum ending up in the east

1 facing the Commander.)
 2

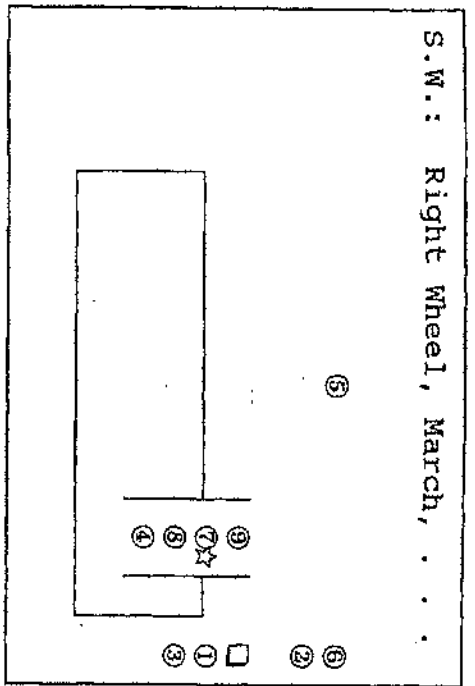

3 COMM: 1. Commander, 2. Carry, 3. Swords.
 4
 5 SR WARD: Eminent Commander: - By authority
 6 of the Grand Encampment of the
 7 United States of America, we present
 8 you the United States Flag. Its place
 9 is on the dais at your right. As
 10 Knights Templar, we pledge
 11 ourselves to protect and defend this
 12 emblem of our country, and to yield
 13 up our lives rather than forfeit our
 14 pledge.
 15
 16 COMM: Sir Knights: - Justly we honor this
 17 flag, symbol of the government that
 18 protects our noble heritage, a heritage
 19 preserved by the precious sacrifices
 20 and true devotion of a united people;

1 a heritage which under the gracious
 2 favor of our Heavenly Father, we
 3 fervently pray may be transmitted in
 4 full measure to our posterity; its
 5 colors like those of our Grand
 6 Standard remind us of purity and
 7 honor, justice and sacrifice, the finest
 8 fruits of Christian civilization.

9
 10 COMM: 1. Commandery, 2. Present, 3.
 11 Swords, Sir Knight Senior Warden: -
 12 Cause the flag to be placed in its
 13 station on my right.
 14

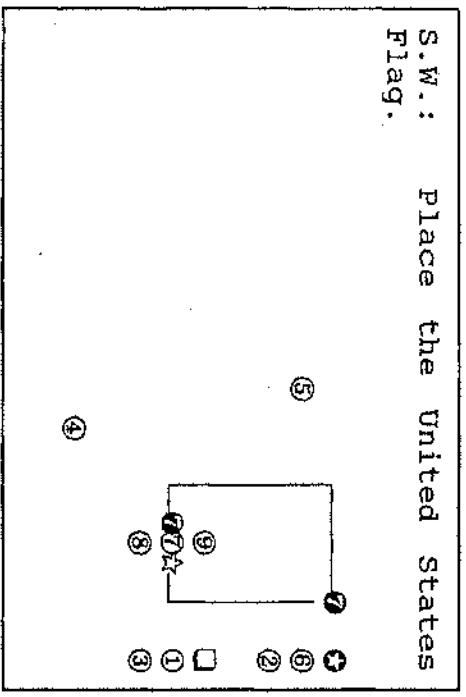

15 SR WARD: Sir Knight Standard Bearer: - Place
 16 the United States Flag. (Standard
 17 Bearer proceeds forward, places the
 18 flag in its receptacle, moves back
 19 two paces, draws sword and sword
 20 salutes the flag, comes to carry

1 swords and takes his place in line,
 2 passing on the north side of the
 3 Standard Guard and comes to present
 4 swords.)

5
 6 COMM: 1. Commandery, 2. Carry, 3. Swords.

7
 8 SR WARD: 1. Standard Guard, 2. About, 3. Face,
 9 4. Forward, 5. March. (When arriving
 10 at their station in the west, the Senior
 11 Warden will command:) 1. Standard
 12 Guard, 2. Halt, 3. About, 4. Pace.
 13

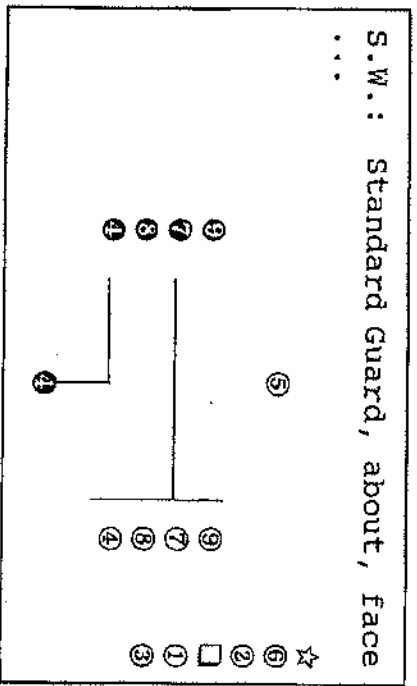

14 COMM: 1. Commandery, 2. Return, 3.
 15 Swords, 4. Be Seated.

FULL FORM OPENING

Reception of Commander

COMM: Officers vacate your stations. Captain General report to the Commander for orders.

COMM: Sir Knight Captain General: - See that the Asylum is in suitable array for my reception. Sir Knight Generalissimo and Excellent Prelate: - Accompany me to my apartment. (Captain General takes his place on the dais, draws sword, and commands:)

CAP GEN: Sir Knight Warder: - Sound the assembly. (He does this by making sure all the Sir Knights are in the Asylum.) Officers: - Take your stations. Sir Knights: - Be Seated.

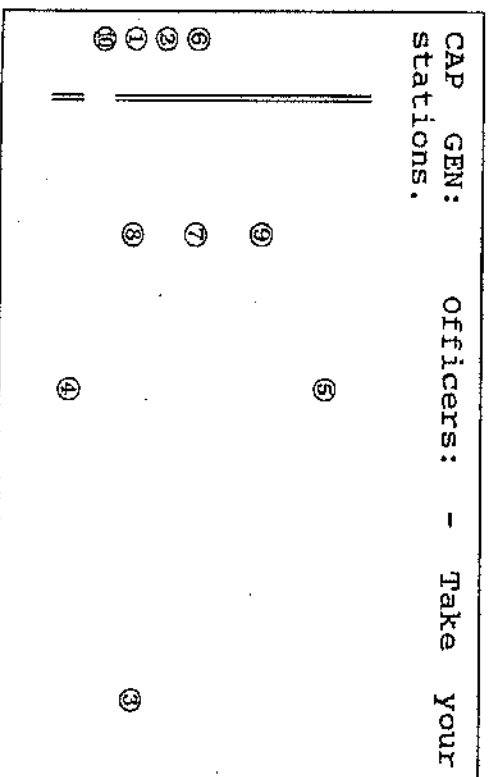

CAP GEN: Sir Knight Senior Warden: - Are all present. Knights Templar. (The Senior Warden arises, takes one step forward, draws his sword, faces the Captain General, and sword salutes. When the Captain General has completed his order, he will sword salute the Senior Warden, and both will come to carry swords simultaneously.)

SR WARD: (The Senior Warden will now face the Junior Warden and give the order.) Sir Knight Junior Warden: - Ascertain if all in the north are Knights Templar.

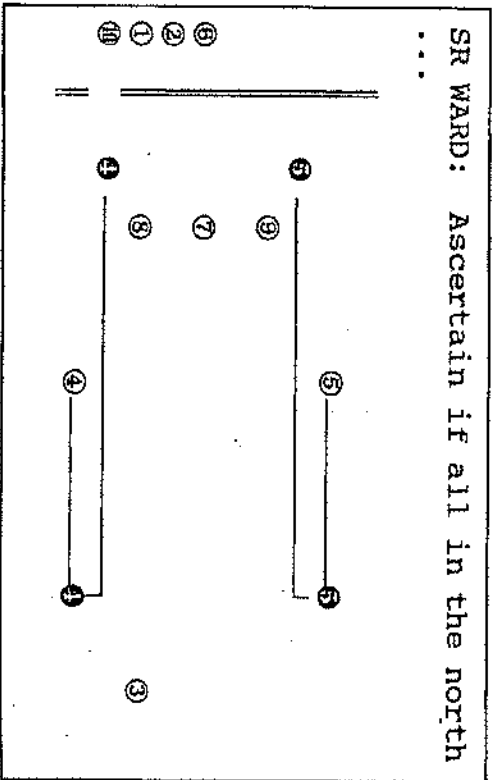

(When called upon the Junior Warden arises, faces the Senior Warden, takes one step

forward, draws his sword and sword salutes the Senior Warden. After the order is given, the Senior Warden will sword salute the Junior Warden and both will come to carry swords simultaneously. They both proceed to the east end of the Asylum, do an about face, and inspect the Sir Knights on the way to the west. Having reached the west end of the asylum, they now face each other and the Junior Warden will report.)

JR WARD: (Sword salute) Sir Knight Senior Warden: - All in the north are Knights Templar.

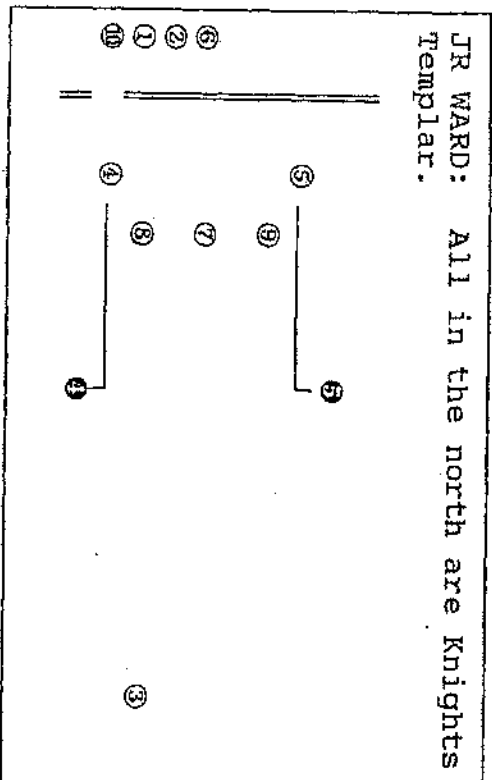

(The Senior Warden will return the salute and both come to carry swords and return to their stations.)

SR WARD: (Sword salute) Sir Knight Captain General: - All present are Knights Templar. (The

Captain General will return the sword salute of the Senior Warden, both come to carry swords. The Senior and Junior Wardens will return swords and be seated simultaneously.)

CAP GEN: Sir Knight Warden: - (Warder arises, takes one step forward, draws sword, and sword salutes.) Post the Sentinel, inform him a Commandery of Knights Templar is about to be opened and direct him to guard accordingly.

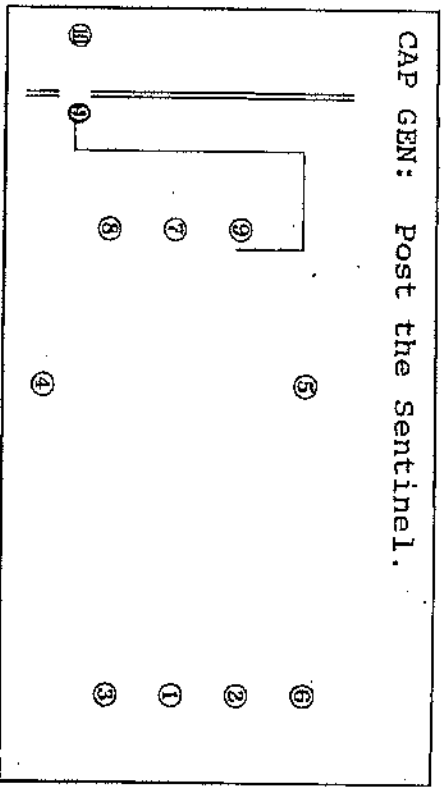

(After giving the order, the Captain General will sword salute the Warder and both come to carry swords simultaneously.)

WARDER: (The Warder will leave his station, go to the door, open it without knocks and inform the Sentinel.) Sir Knight Sentinel: - A Commandery of Knights Templar is about to be opened and you are directed to guard

accordingly.

SENT: Sir Knight Warden: - It shall be done. (The Warder closes the door and gives knocks, xxx xxx xxx x which are answered by the Sentinel. The Warder returns to his station, sword salutes the Captain General, and reports.)

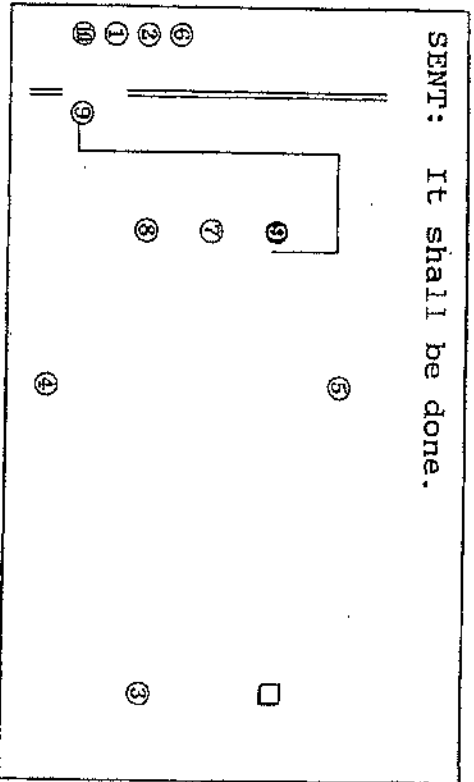

WARDER: Sir Knight Captain General: - The Sentinel is at his post and the Asylum is duly guarded. (The Captain General returns the salute of the Warder thus releasing the Warder who returns his sword and is seated.)

CAP GEN: Sir Knight Senior Warden: - (The Senior Warden arises, faces the Captain General, draws his sword, gives sword salute.) Form the lines for the reception of the Commander. (The Captain General returns

the Salute, thus releasing the Senior Warden.)

C.G.: Form the lines...

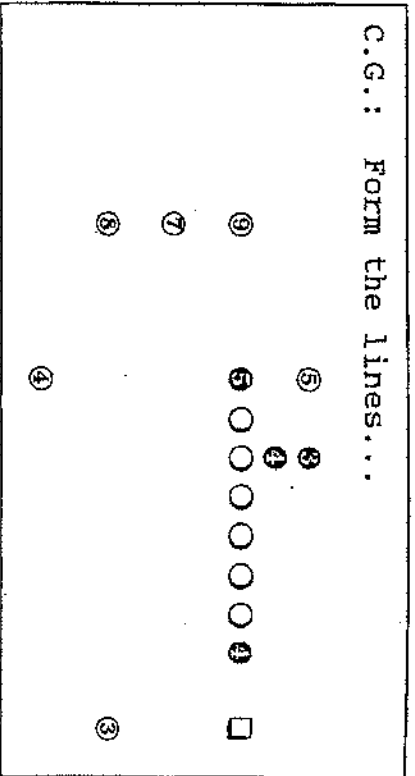

SR WARD: (The Senior Warden leaves his station, moves the "shortest" distance to the east of the Asylum, stopping in front of the Generalissimo's station on the Asylum floor. He faces west and commands:) 1. Commandery, 2. Attention, 3. Fall-in. (At the command "Fall-in", all not excused, without drawing swords, promptly fall-in, single file, facing east, dressing on the Senior Warden, graduated in size from front to rear. The Junior Warden falls in on the west end or bottom of the line.)

CAP GEN: All Sir Knights on the side lines be seated. (All officers remain standing except the Recorder and Treasurer. The Captain General takes his station on the north side of the Asylum, six or eight paces from and in the center of the line, facing the line. After the Captain General has taken his position,

the Senior Warden takes his position on the north side of the Asylum about three paces in front and center of the line, facing the line.)

the Senior Warden takes his position on the north side of the Asylum about three paces in front and center of the line, facing the line.)

SR WARD:

1. Left, 2. Face, 3. Draw, 4. Swords, (including the Standard Guard) 5. Count, 6. Twos. (The Senior Warden dresses the line, returns to his station in front of the line, and commands:) 1. Present, 2. Swords. (The Senior Warden faces about, sword salutes the Captain General and reports.)

SR WARD:

Sir Knight Captain General: - The lines are formed. (The Captain General returns the salute, releasing the Senior Warden. The Senior Warden takes his station as right guide by the shortest route, without command.)

CAP GEN:

1. Carry, 2. Swords, 3. Open ranks. (The Senior and Junior Wardens step back to just in front of the Captain General's station on the dais to mark the new alignment of the rear rank. The Captain General goes to the right flank to see that the Wardens are in line parallel to the front rank. He then places himself, facing the left, three paces in front of the line and commands:)

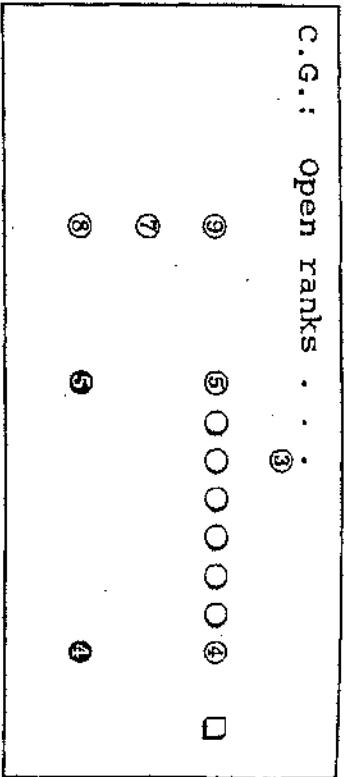

CAP GEN: March. (The front rank, the odd numbered

knight will dress to the right without closing the interval; the even numbered knights who constitute the rear rank, cast their eyes to the right, step backwards, halt a little in the rear of the alignment, then dress to the right without closing intervals on the line established by the Wardens. The Captain General superintends the alignment of the front and rear ranks, then places himself, facing the left, three paces in front of the front rank and commands:)

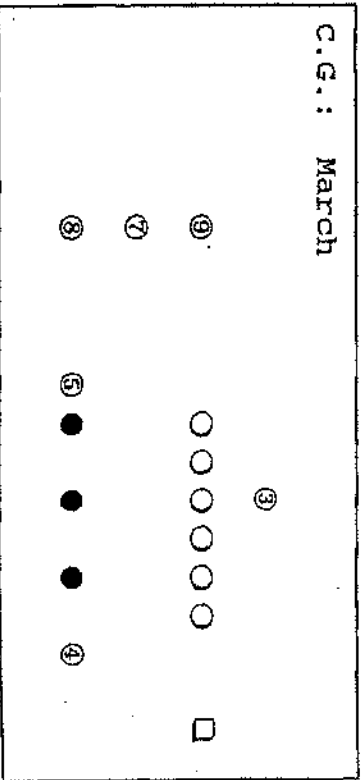

CAP GEN: Front. (The Wardens resume their places in the front rank and the Sir Knights cast their eyes to the front.)

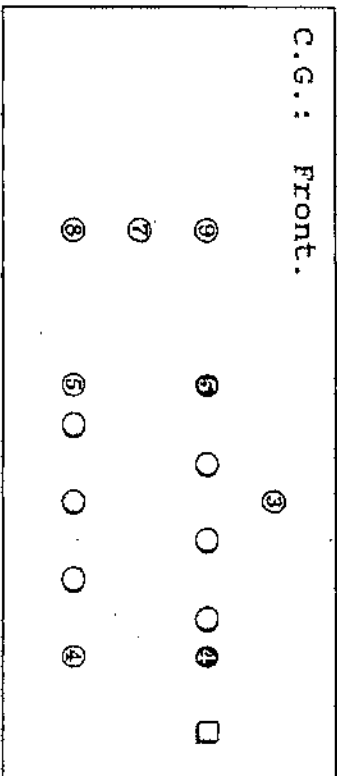

CAP GEN: 1. Form two divisions, 2. Files, 3. Cover.

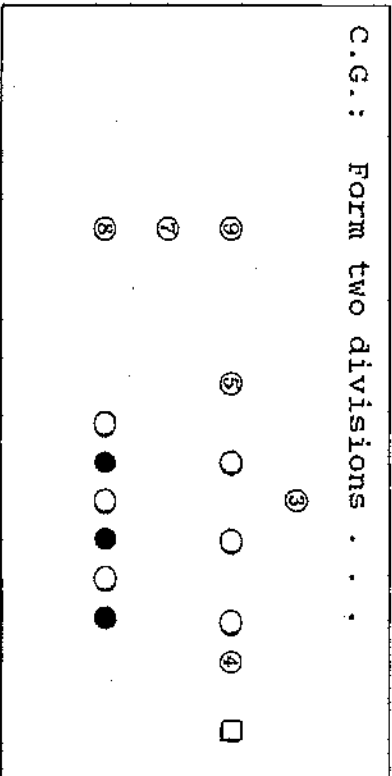

(At the command "Cover", the rear rank takes two right steps - ten inch step - and cover on the front rank and becomes the first division.)

CAP GEN: 1. Front rank, 2. About, 3. Face.

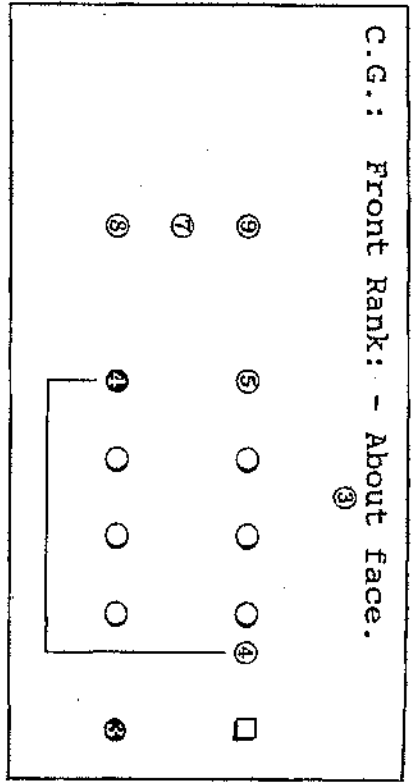

(At the Command "Face", the front rank faces about and becomes the second division. The Senior Warden will about face with the front rank and without command take his place on the left of the first division, opposite the Junior Warden. The Senior Warden will march forward one pace beyond the first division, right face and march to the left of the first division. The Captain General will now take his place on the dais in the east.)

CAP GEN: Sir Knight Junior Warden: - (The Junior Warden steps to the center of the lines, left faces to the east, sword salutes the Captain General.) With the Standard Guard as escort, repair to the apartment of the Commander and inform him that the lines are formed for his reception. (The Captain General returns the Junior Warden's salute thus releasing him

to carry out the order.)

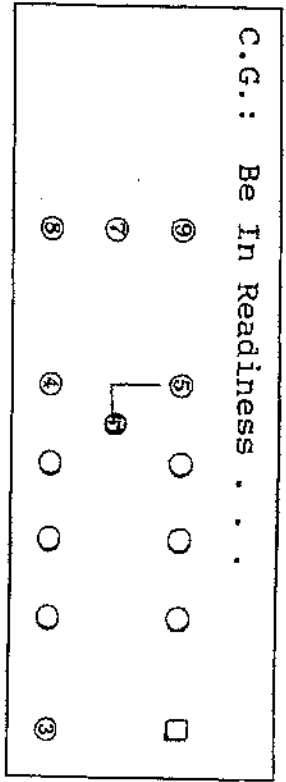

JR WARD: (Does an about face, steps forward to the Standard Guard and commands.) Standard Guard as escort: - 1. Right, 2. Face.

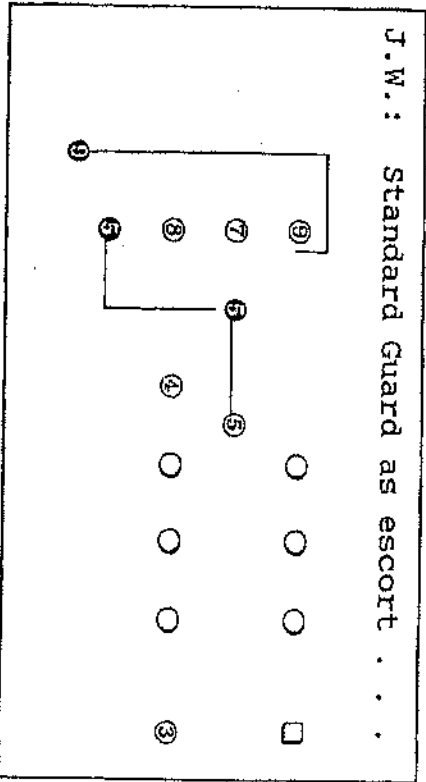

JR WARD: 1. Forward, 2. March. 3. Column right, 4. March. (As the Junior Warden approaches the Standard Guard, the Warden will quickly pass in the rear of the Standard Guard and takes his place on the south side of the Asylum door and sword salutes the escort as they pass out of the Asylum door, remaining

at the door until the escort, Commander, and his staff return.)

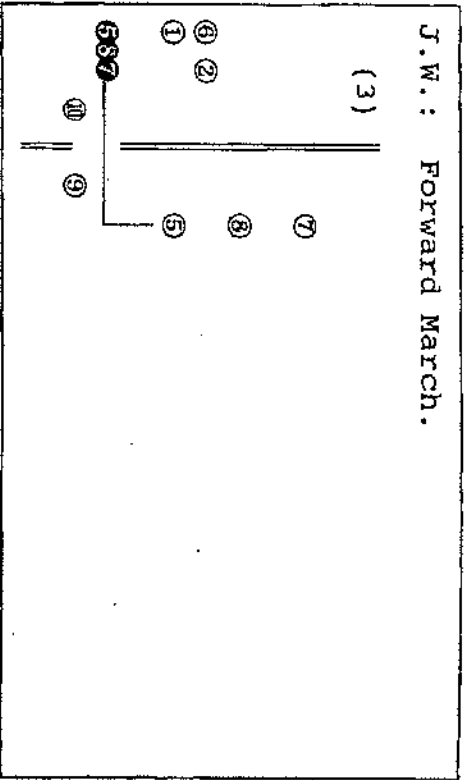

JR WARD:

(As the escort reaches the apartment of the Commander, the Junior Warden will give the commands.) 1. Standard Guard, 2. Halt, 3. Right or left, (as the case may be) 4. Face, 5. Present, 6. Swords. Eminent Commander: - The lines are formed and the escort awaits your pleasure. (When the Junior Warden addresses the Commander, he will come to sword salute.)

COMM:

Sir Knight Junior Warden: - It is my pleasure to be escorted into the Asylum. (The Commander returns the Junior Warden's salute with his hand, thus releasing the Junior Warden to carry out the order.)

COMM: It is my pleasure to be escorted into the asylum.

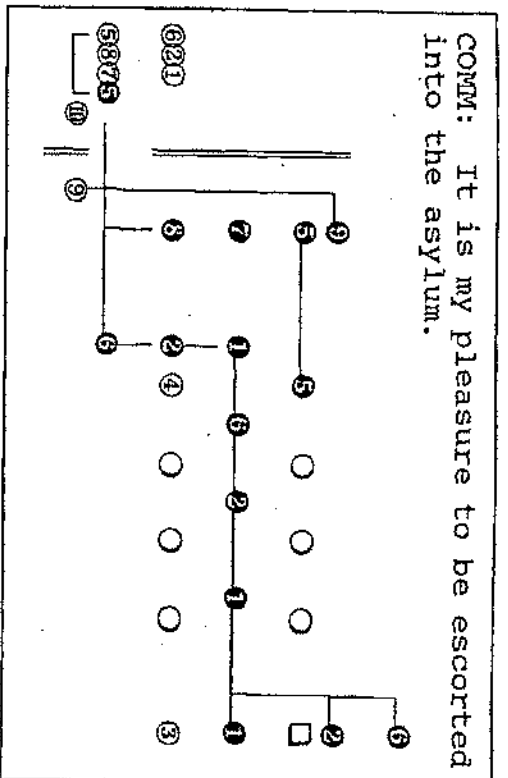

JR WARD:

1. Escort, 2. Carry, 3. Swords. 4. Left or right face, (as the case may be) 5. Forward, 6. March. (After the command "face", the Junior Warden will take his place on the opposite end of the line and the Standard Guard will return to the Asylum in reverse order. As the escort approaches the Asylum door, the Warden will sword salute and announce:)

WARDER:

The Eminent Commander approaches. (After the escort and the Commander passes, the Warden will come to carry swords, go to his station and come to present swords.)

JR WARD:

(The Junior Warden will march the escort to their stations in the west and command.) 1. Escort, 2. Halt, 3. Right, 4. Face, 5. Present, 6. Swords. (The Junior Warden takes his station on the right of the second division

facing the Senior Warden.)

CAP GEN:

(When the Warden announces the "Eminent Commander approaches" the Captain General will command.) 1. Commandery, 2. Attention, 3. Present, 4. Swords. (Only the Sir Knights in line, the Standard Guard and the Warden will present swords. The Sir Knights along the sidelines will arise, uncover and remain uncovered until the command "Carry swords" is given at which time they will recover.)

(As the Eminent Commander approaches the bottom of the lines, he will halt and give the Junior Warden time to return to his station and come to present swords. As the Commander, Generalissimo and Prelate, in that order, pass through the lines, the Commander only will uncover. When they have passed through the lines, he will recover. The Captain General will sword salute the Commander when he has reached his station, the Generalissimo and the Prelate will take their stations.)

COMM:

(When the Commander arrives at his station, he will about face, draw his sword and command:) 1. Carry, 2. Swords, 3. Sir Knights on the sidelines, 4. Be seated.

Communicate Across the Lines

COMM:

1. For rehearsal. 2. Officers, 3. Post (The Generalissimo and the Captain General with swords drawn leave the dais together. The Generalissimo will take the station on the left of the second division and the Captain General on the right of the first division, facing each other. The Commander takes his station two paces to the right and midway facing the lines.)

COMM: For Rehearsal.

⑨ ○ ○ ○ ○ ②

⑦ ①

⑧ ④ ○ ○ ○ ○ ③

COMM: Officers, post.

⑨ ○ ○ ○ ○ ○ ② ②

⑦ ① ①

⑧ ○ ○ ○ ○ ○ ③ ③

COMM:

First Division: - Communicate to the Second Division the Pilgrim Warriors Word. 1. Guard, 2. Give cuts, 3. Communicate, (Word given) 4. Carry, 5. Swords. (At the command guard, turn the left foot square to the left, turning on the left heel and plant the right foot firmly about eighteen inches to the front, feet at right angles, the weight resting principally on the right foot, the shoulders oblique to the front, head and eyes square to the front. At the same time raise the sword hand on a line with the lower part of the belt and about two inches from it, the guard about three or four inches to the right of the belt clasp. Drop the sword diagonally to the left, the blade tip about eighteen inches in front of the left shoulder, edge to the front, thumb on back of the grip. At the command "carry", come to the position of guard. At the command "swords" come to the position of carry swords.)

COMM:

Second Division: - Communicate to the First Division the Pilgrim Penitent Word. 1. Guard, 2. Give cuts. 3. Advance and communicate. (The lines will come to guard as before and give the same cuts, but on the command "advance and communicate", they will advance on the right foot, placing their left feet beside each other, the swords forming an arch of steel as in cross swords, placing their left hand on each others right shoulder and communicate the word.) (At

COMM:

the command "carry", they will return to guard and on the command "swords" will come to carry swords.) 4. Carry, 5. Swords.

1. Return, 2. Swords.

COMM:

First Division communicate to the Second Division the Immaculate Word. 1. Sir Knights, 2. Kneel, (At the command "kneel", the Sir Knights will take one step forward with the right foot and kneel on the left knee.) 3. Uncover, (At this command, the Sir Knights will remove their chapeau with the left hand and place it on the right shoulder.) 4. Deposit, 5. Chapeau. (At the command "chapeau", the Sir Knights will remove the chapeau from the right shoulder and place it on the floor at the left of the right foot, feathers to the left, peak pointing towards the body, cross up.)

COMM:

Sir Knights: - Interlace fingers. (At this command the Sir Knights that make up the First Division, will cross their forearms about halfway between the elbow and the wrist, the right arm over the left. The Sir Knights that make up the Second Division will interlace; their fingers with the Sir Knights of the First, Division.)

COMM:

Sir Knights: - As your fingers are thus strongly interlaced, so should the hearts of all Knights Templar be firmly united in the bonds of friendship and brotherly love. Over

this symbol of our faith, communicate. (At the command "communicate", the first Division with arms crossed, right arm over left, fingers interlaced with the Second Division, will give the Word. The Second Division with fingers interlaced with the First Division, will cross their forearms halfway between the elbow and wrist and give the response.)

COMM:

Sir Knights: - 1. Secure, 2. Chapeau, 3. Recover, 4. Arise. (At the command "secure", the Sir Knights will place their left hand on the peak of the chapeau. On the command "chapeau", they will place the chapeau on the right shoulder. On the command "recover", they will place the chapeau on their head and drop the left hand to their side. On the command "arise", they stand and place their weight on the left foot and bring the right foot back along side of the left, dressing to the east, without command. After the lines have dressed up, the Commander, Generalissimo and Captain General will return to the dais.)

Inspection and Review

COMM:

Sir Knight Captain General: - (Captain General draws sword and salutes the Commander.) Form the lines for inspection and review. (The Commander returns the Captain General's salute with his hand, thus releasing him to perform the order. The Captain General, with sword drawn, faces the lines and commands.)

CAP GEN:

For inspection and review. 1. Officers, 2. Post.

C.G.: For Inspection and review. Officers post.

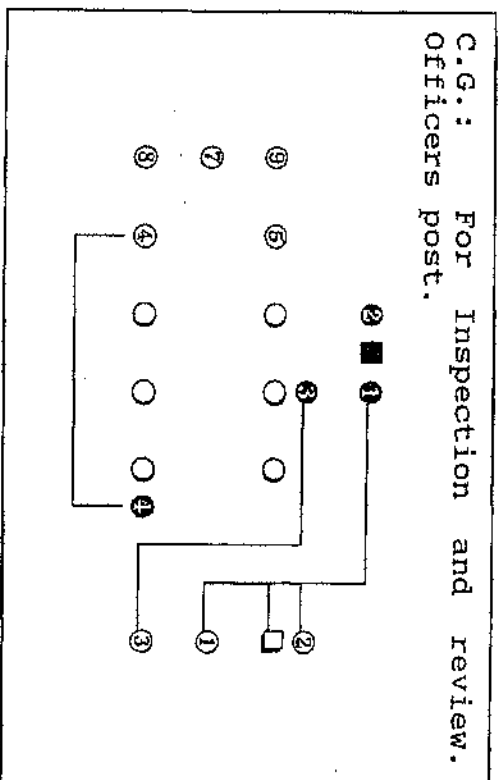

At the command "post", the Senior Warden will take one step back, make a right face, and march at the rear of the First Division to the east. When he has reached about one pace to the right of the First Division, he

will make a left face and go to his post at the right of the First Division. At the same time, the Captain General will take his station at the front of the Commandery. After the Captain General and the Senior Warden have reached their stations, the Commander, Generalissimo and Inspecting Officer, with their swords hooked-up, will take their stations in the rear of the Captain General.)

CAP GEN: 1. Reform line, 2. Second Division, 3. About, 4. Face, 5. Close ranks, 6. March.

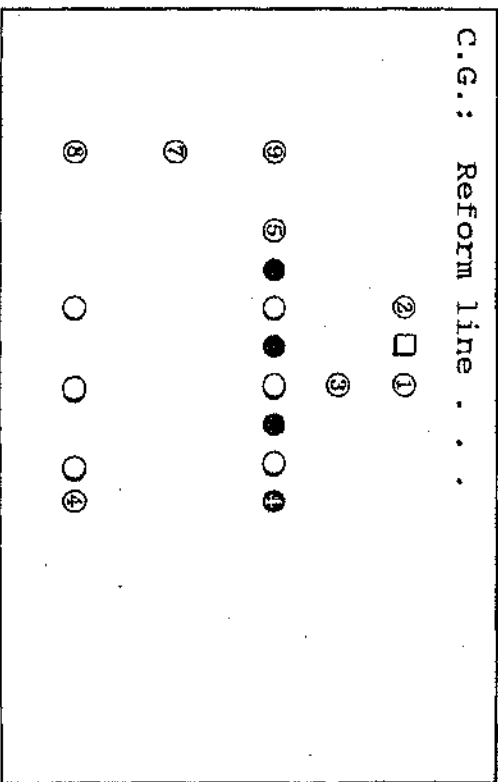

(On the command "about face" the front rank will face about. On the command "march" the rear rank will march forward and retake their positions in the Second Division. The Senior Warden on the right of

the line and the Junior Warden on the left of the line.)

CAP GEN: 1. Backward (Guide right), 2. March, 3. Halt, 4. Right, 5. Dress, 6. Front, 7. Count, 8. Twos.

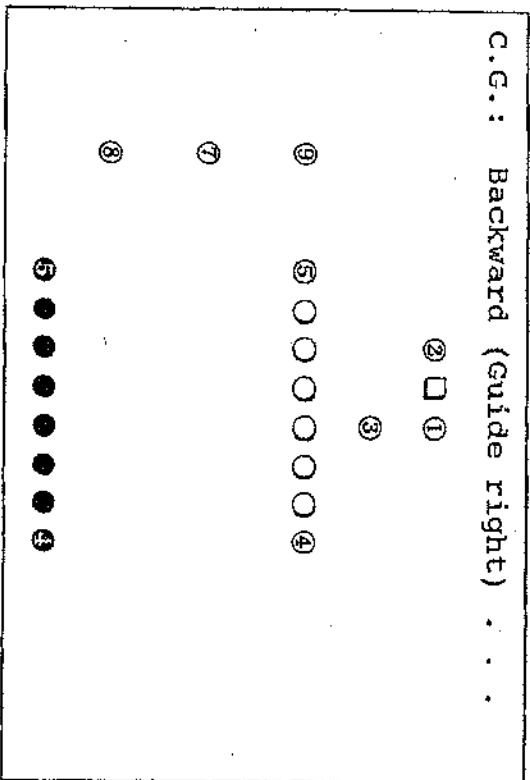

After the counting of twos, the Captain General will designate platoons by going to the line and stating the left of the First Platoon and the Right of the Second Platoon. Do not use the sword as a pointer to designate platoons!

CAP GEN: 1. Draw, 2. Swords, (The Standard Bearer will not draw swords. He will secure the Beaucant) 3. Second platoon, left step, 4. March, 5. Halt, 6. Commandery, 7. Present,

8. Swords.

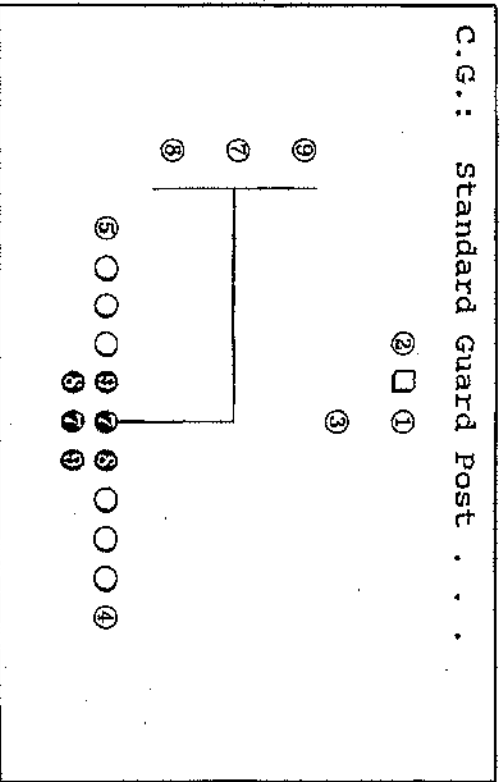
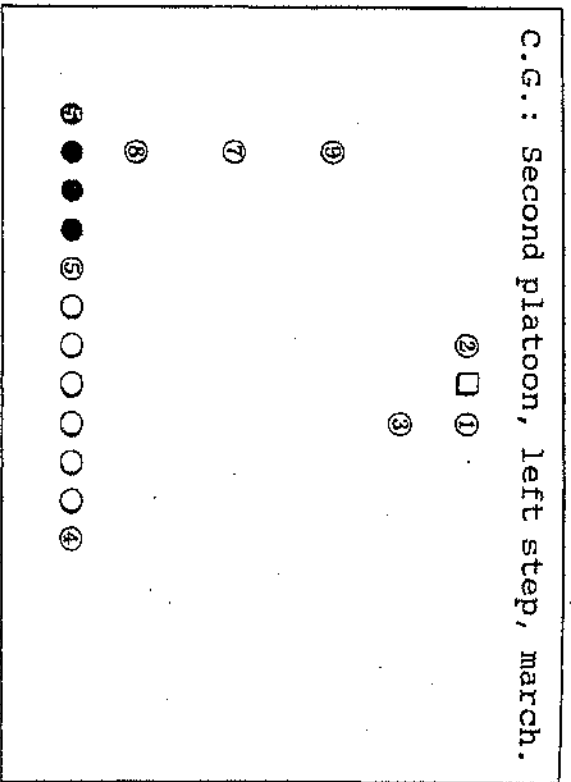

SW BEAR: 1. Standard Guard, 2. Carry, 3. Swords, 4. Forward, 5. March. (At the command "march", the Standard Guard will march towards the east of the Asylum. Upon reaching the interval in the line prepared by the Captain General, the Sword Bearer will command.)

SW BEAR: 1. Standard Guard, 2. Right Wheel, 3. March. (After passing through the interval, the Sword Bearer will command.)

SW BEAR: 1. Left about, 2. March, 3. Left Oblique into Line, 4. March, 5. Halt, 6. Right, 7. Dress, 8. Front, 9. Present, 10. Swords.

CAP GEN: 1. Commandery, 2. Carry, 3. Swords, 4. Prepare for inspection, 5. Open ranks.

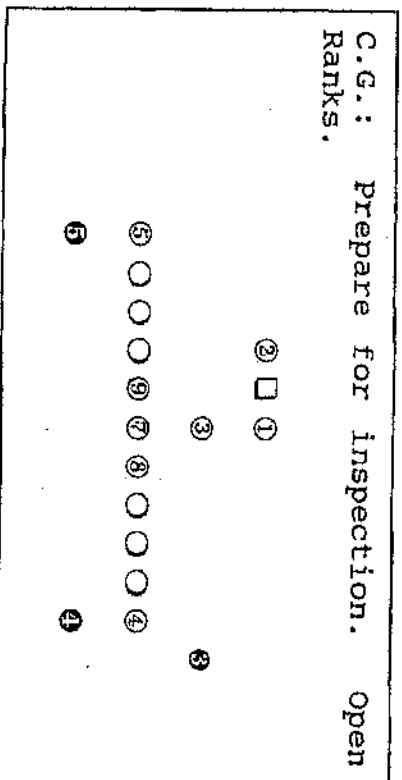

(At the command "open ranks", the Senior

and Junior Wardens will step backwards six steps to mark the alignment of the rear rank. The Captain General goes to the Wardens and checks the line to see if it is parallel to the front rank then takes his position facing the left three paces in front of the right file and commands:)

CAP GEN: 6. March.

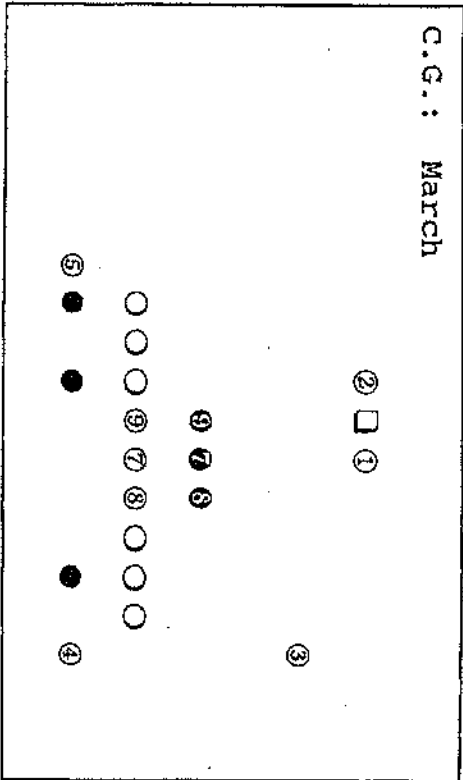

At this command, the Standard Guard will take two paces forward, the odd numbered knights dress to the right without closing the interval. The even numbered knights cast their eyes to the right, step backwards, halt a little in the rear of the alignment of the Wardens and then dress to the right without closing interval on the line established by the Wardens. The Captain

General superintends the alignment of the front rank and verifies the alignment of the rear rank, then places himself facing left three paces in front of the front rank and commands:

CAP GEN: 7. Front.

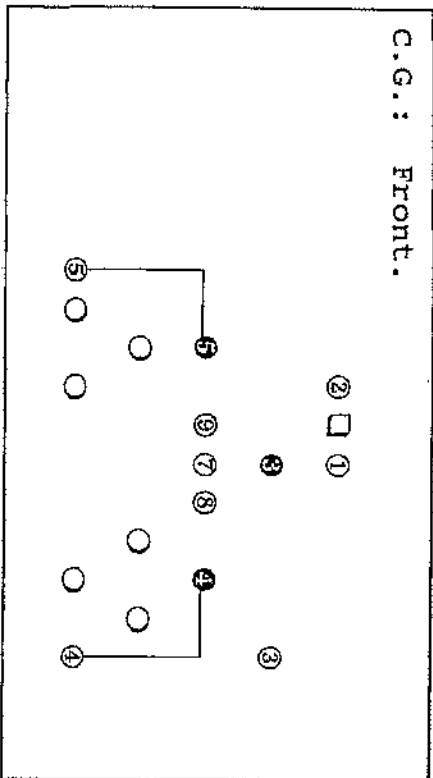

(He then takes his position in the front and at the center of the Commandery. Also, at the command "Front", the Senior and Junior Wardens will take their positions in front and at the center of their respective platoons, on line with the Standard Guard.)

CAP GEN: (The Captain General faces the Commander, sword salutes and reports.) Eminent Commander: - The lines are formed. (The Commander hand salutes the Captain General after which he comes to carry.)

COMM: (The Commander will then face the Inspecting Officer, hand salute and report.)
Eminent Sir - The lines are formed for your inspection.

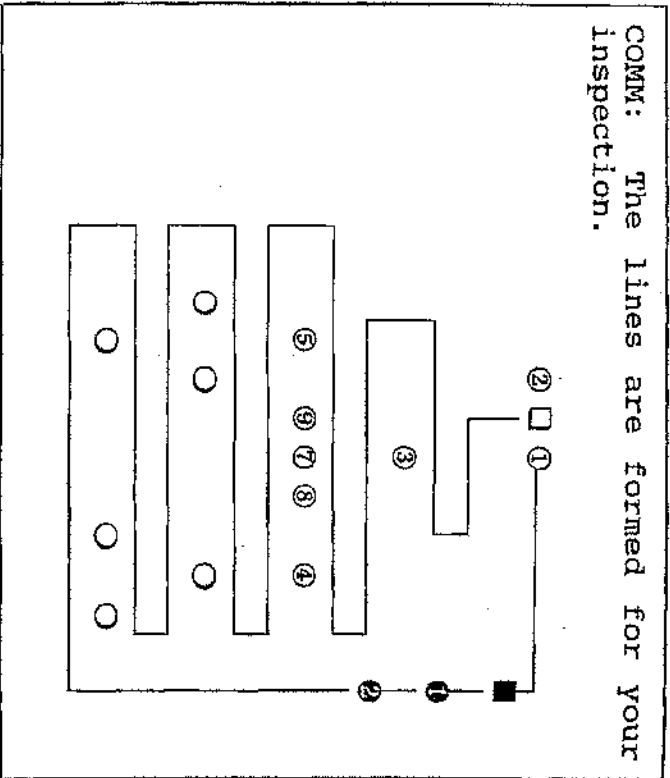

COMM: The lines are formed for your inspection.

(The Inspecting Officer will hand salute the Commander and invites the Commander and the Generalissimo to accompany him on the inspection.)

CAP GEN: The Inspecting Officer, Commander and Generalissimo, in that order, will inspect the lines passing first in front of the Captain General from his right to left, then to his rear, then to the line of the Senior Warden,

Standard Guard and Junior Warden, to the front and right of this line, passing to the left of this line and then to the rear, then back to the right of the first line after the Officers. Starting on the right of this line in the front going to its left, and return at the back or the rear of this line to the front of the next line in the rear. After they have passed, the Captain General will face about and command:

CAP GEN:

Inspection Swords.

(This command does not apply to the Standard Guard or the Wardens. He will again face about and face the front waiting for the inspecting officers to return. The Inspecting Officer, Commander, and generalissimo will pass around the right flank of the Sir Knights in the line and take their position in the north. The Commanders position is in the center, in front of and facing the Commandery. The Inspecting Officer takes a position on his right, facing the Commandery. The Generalissimo takes position two paces in the rear and one pace to the right of the Inspecting Officer.)

COMM:

Sir Knight Captain General: - To your post.

(The Captain General will sword salute the Commander who returns the salute with his hand. The Captain general will return his sword and takes a position on the left of the Commander and one pace in the rear. the Commander will now draw his sword and

may exercise the knights in a sword manual, closing with carry swords. The sword manual shall be given when the Commandery is in open order. After the Commander is finished with the sword manual, he will return his sword, face the Captain General, and give the order:)

CAP GEN: Sir Knight Captain General: - Pass in review.

(The Captain General will draw his sword, sword salute the Commander and then take his position in front of the Commandery. The Commander will return the salute of the Captain General with his hand.)

CAP GEN: 1. Close ranks.

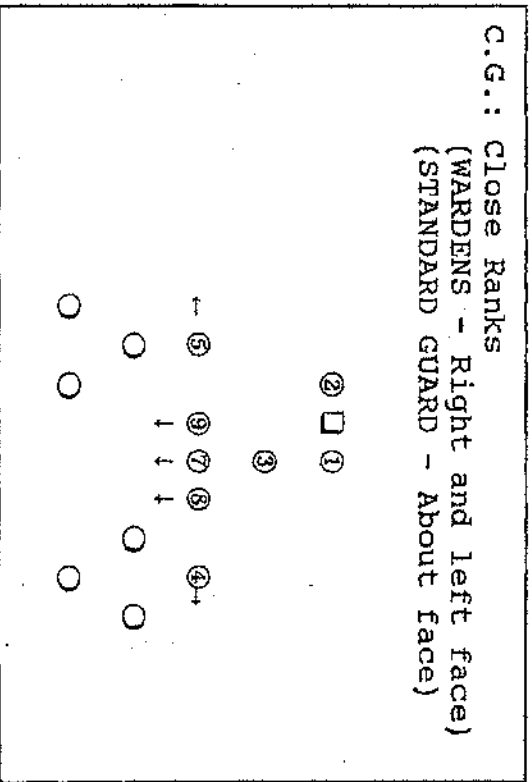

On this command the Senior Warden will

make a right face, the Junior Warden will make left face and the Standard Guard will do an about face.

CAP GEN: 2. March.

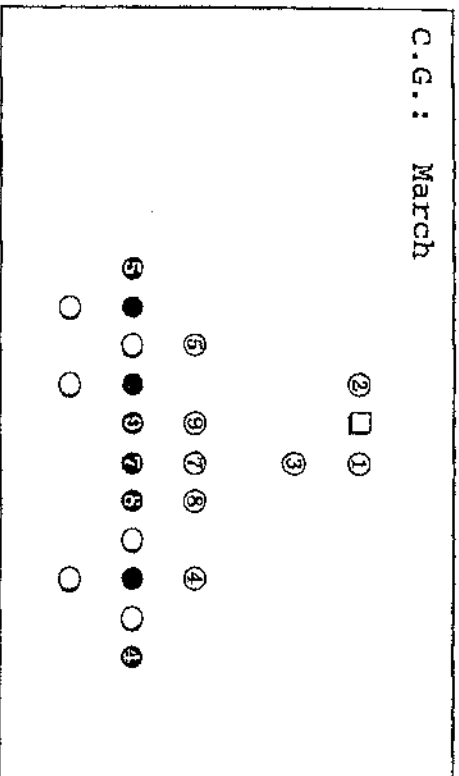

On this command the rear rank, Standard Guard, Senior and Junior Wardens will all move at the same time. The Senior Warden to the right of the line, the Junior Warden to the left of the line, the Standard Guard to the interval in the line between the First and Second platoons, and the knights making up the rear rank will move into the front rank, all dressing to the right on the Senior Warden. The Captain General at this time will dress the line.

After dressing the line the Captain General will take his position at the front of the

Commandery and command:)

CAP GEN: 1. Backward, Guide Right, 2. March. 3. Halt, 4. Count, 5. Threes. (The Standard Guard does not count off.)

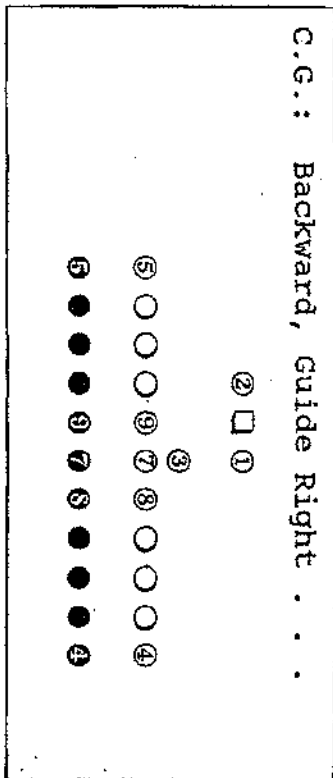

Pass in Review

CAP GEN: 1. Pass in review, 2. Right by Threes, 3. March.

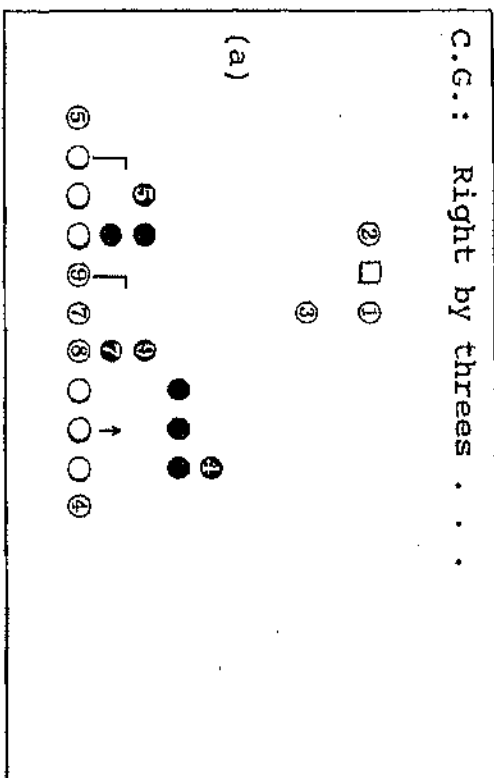

(On the command "right by threes", the Senior Warden will move ahead and in line with the number one knight in the first three, thus takes his position as right guide. These first three knights will march straight ahead, the remaining lines will right wheel and march forward to where the number three knights will come on line with the number three knight of the first column and make a column left which is followed by the other threes. The Junior Warden will fall in the rear of the number three knight of the last threes. The Captain General will march the

knights around the Asylum in front of the Inspecting Officer, Commander and Generalissimo by the following commands:)

CAP GEN: 1. Column, 2. Left, 3. March, (As they pass by the Inspecting Officers, gives commands 4. and 5.) 4. Eyes, 5. Right.

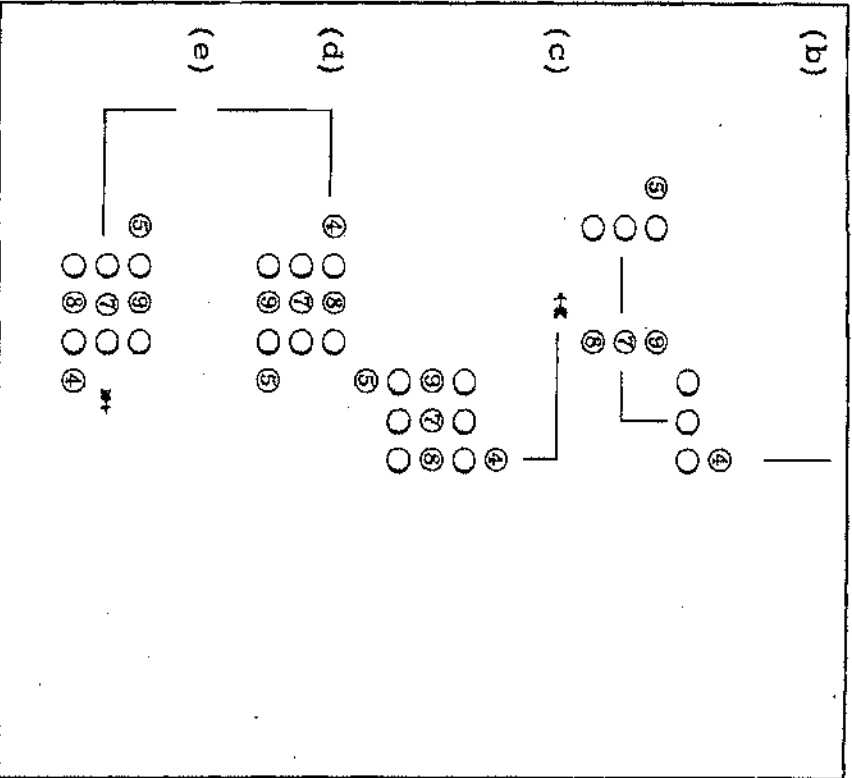

(On this command the number one knights

will look straight ahead, the number two and three knights will turn their eyes toward the Inspecting Officers. After they have passed, he will command.)

CAP GEN: 1. Ready, 7. Front.

CAP GEN: (After passing the Inspecting Officers, he will command.) 1. Column, 2. Left, 3. March, 4. Column, 5. Left, 6. March, 7. Threes left into line, 8. March. (At the command "march", the number three knights will start to mark time turning slowly to their left, the number one and two knights will do a left wheel into line keeping abreast with the knights on their left until they come into line again with the knights on their right at which time they will all dress on the Senior Warden. They will mark time until the command halt.) 9. Halt.

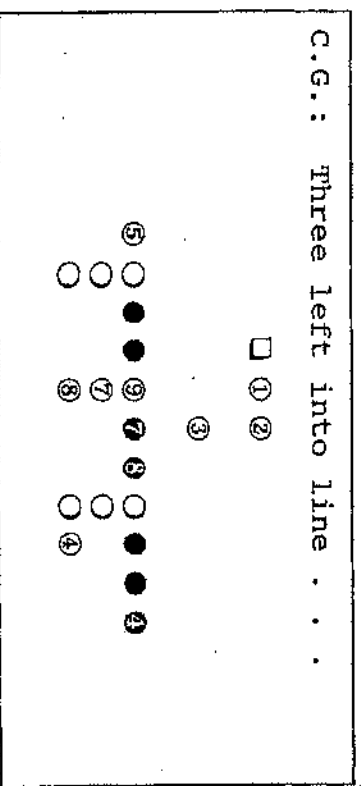

CAP GEN: 1. Present, 2. Swords.

C.G.: Present swords.

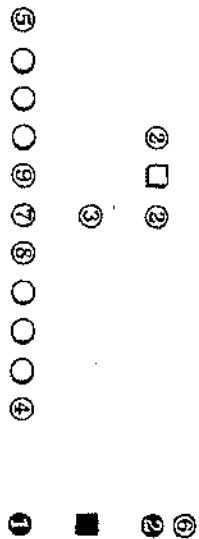

At this time all Sir Knights in line, including the Wardens, Sword Bearer and Warden, will present swords. The Captain General, from his position at the center of the Commandery, will face about and sword salute the Commander who will return the salute with his hand. Nothing is said at this time. The Inspecting Officer, Commander, and Generalissimo return to the dais at secure swords.

Triangle

COMM:

Sir Knight Captain General: - Form the triangle preparatory to our devotions. (The Captain General at the front and center of the Commandery will sword salute the Commander who will return the salute by hand. The Captain General will face the line and command.)

CAP GEN:

1. Standard Guard, 2. Post.

C.G.: Standard Guard, Post.

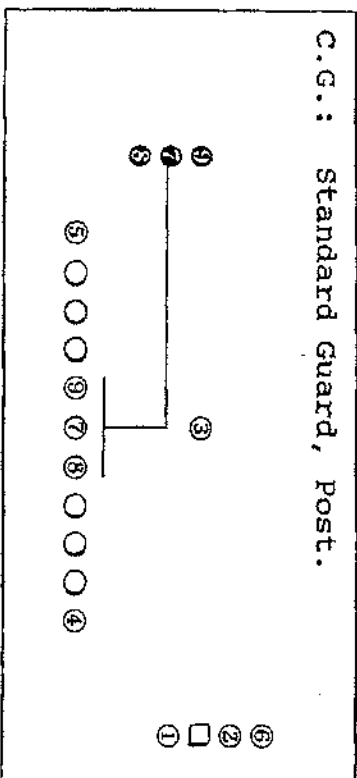

SW BEAR:

1. Standard Guard, 2. Carry, 3. Swords, 4. Forward, 5. March, 6. Left Wheel, 7. March, 8. Left About, 9. March, 10. Standard Guard, 11. Halt, 12. Present, 13. Swords.

CAP GEN:

1. Carry, 2. Swords, 3. First Platoon Left Step, 4. March. (Closing interval Senior Warden also left steps.) 5. Halt, 6. Return, 7. Swords. (On this command all Sir Knights, including the Standard Guard, return swords.)

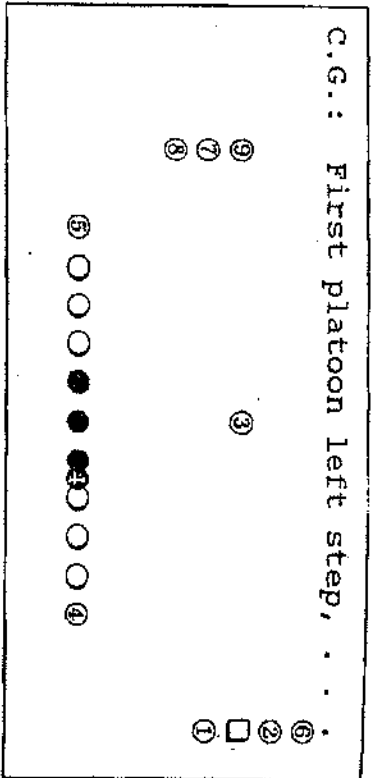

CAP GEN: 1. Count, 2. Threes, 3. Threes right, 4. Close order, 5. March, 6. Halt, 7. Left, 8. Face.

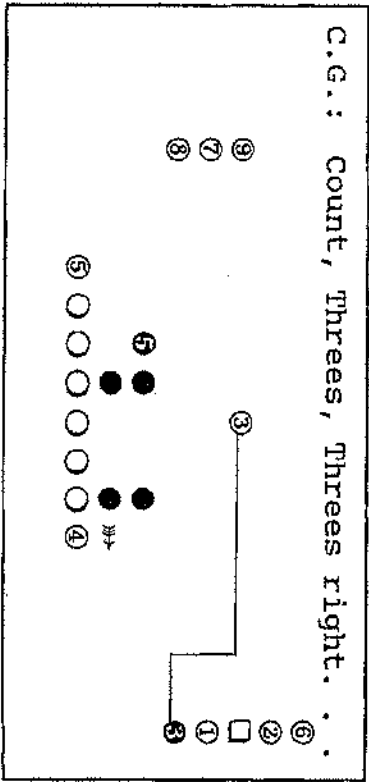

(At the command of "threes right, close order, march", the number one knight will mark time turning to his right as a guide for the number two and three knights who will at the same time do a right wheel keeping line with the knight on the right. At the command "halt", they should be facing the east. The Senior Warden will be ahead of the number one knight. On the command

"left face" all will turn at the same time facing to the north. In this position the rear rank becomes the first division, the middle rank the second division and the front rank becomes the third division. The Junior Warden is on the left of the third division. The Captain General takes his station on the dais.)

CAP GEN: 1. To form Triangle, 2. Officers, 3. Post, 4. March.

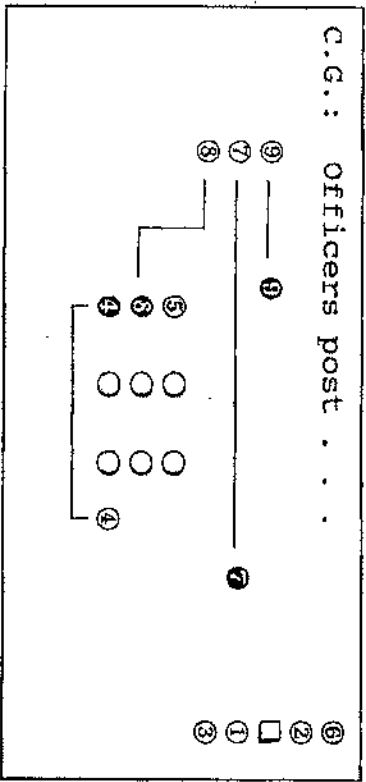

(The Senior Warden will right face and pass by the right and rear of the first division, and take his place at the left of the first division, facing east. The Junior Warden will right face to face his division. The Standard Bearer, Sword Bearer and Warden will march from the west in close order toward the east. The Warden will move by left oblique from the Standard Bearer equal to the length of a division, halt, and face to the front, thus becoming a guide for the

second and third divisions. When the Warden has reached his position, he will look to his right and guide on the Senior and Junior Wardens who are at their positions at the left of the first and third divisions. The Sword Bearer will move by right oblique to between the Senior and Junior Wardens to the left of the second division, halt, and face his division. The Standard Bearer with the Beauceant will march forward in front of and one pace past the lines, halt, about face, and wait.)

CAP GEN: 1. Form triangle.

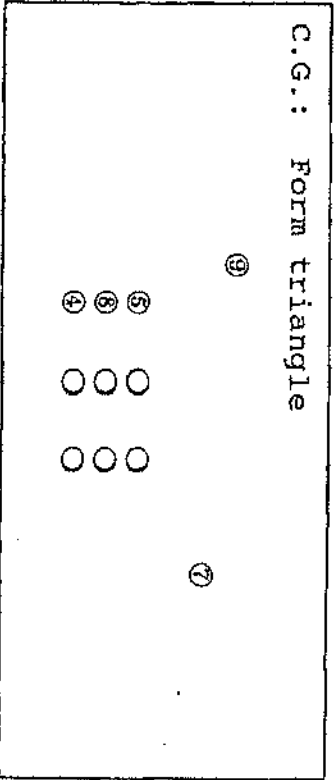

SR WARD: First Division: - Stand Fast. (He then makes a left face.)

SW BEAR: Second Division: - Left Wheel. (He then makes a left face and acts as a moving pivot for the Second Division.)

JR WARD: Third Division: - 1. Forward, 2. Guide Left. (He then faces the left.)

CAP GEN: March.

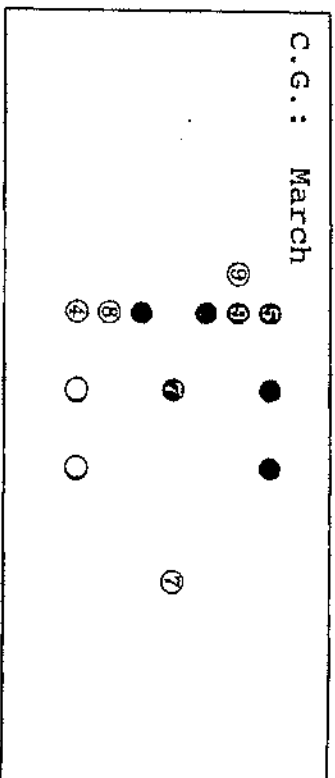

(The Third Division will move forward. The Warden will take one step backward and when the Third Division has passed will step back into line between the Junior Warden and the Second Division.)

CAP GEN: Halt

JR WARD: Third Division: - 1. About, 2. Face, 3. Right, 4. Dress, 5. Front

SW BEAR: Second Division: - 1. About; 2. Face, 3. Right, 4. Dress, 5. Front. (The Second Division will wheel to its left and halt on the line of the Senior and Junior Wardens. After the second division has passed, the Standard Bearer will march forward to within one pace of the Second Division, halt and about face with the Second Division.)

CAP GEN: First and Third Divisions: - 1. Inward wheel, 2. March, 3. Halt. (The Captain

General returns his sword, hands salutes the Commander, and Reports.)

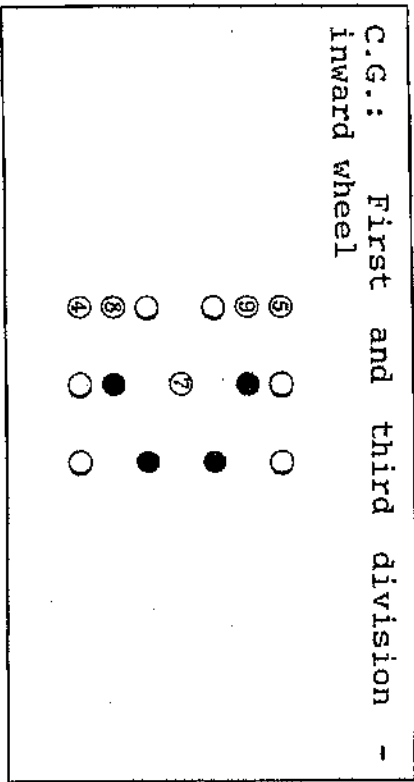

CAP GEN: Eminent Commander: - The triangle is formed.

COMM: 1. Commandery, 2 Attention. (All Sir Knights not in the triangle will stand, uncover and recover on command, and be seated at command 'arise'.)

COMM: Sir Knight Generalissimo, Captain General and Excellent Prelate accompany me to the triangle. (All officers on the dais, except the inspecting officer, will descend and halt at the foot of the dais to give the Prelate an opportunity to enter the Triangle. The officers will secure swords before leaving their stations, dropping swords on arrival at the Triangle.)

COMM: Accompany me to the Triangle.

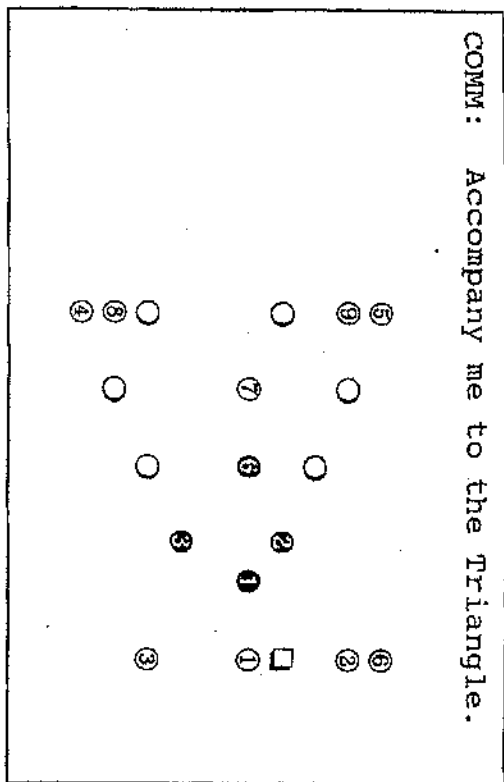

COMM: Sir Knights: - 1. To your devotions, 2. Kneel, 3. Uncover. (At the command "kneel", the Sir Knights at the Triangle will step back with the left foot and kneel on the left knee. At the command "uncover", they will uncover with the left hand and place the chapeau on their right shoulder. The Standard Bearer with the Beauceant at order will uncover but will not kneel. The Prelate offers a prayer ending with the Lord's Prayer.)

COMM: 1. Sir Knight, 2. Recover, 3. Arise. (At the command "arise", the Standard Bearer will resume carry of the Beauceant. The Commander, Generalissimo, Captain General and the Prelate will return to their stations as follows: the dais officers will about face, secure swords, and march forward to the

foot of the dais opposite their stations and halt, thus permitting the Prelate to take his station. They then ascend the dais, about face, drop swords, remaining standing.)

COMM: Arise.

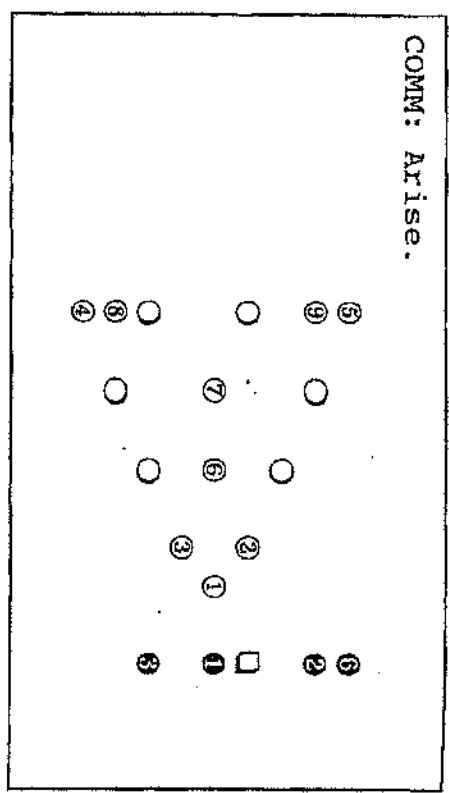

COMM: Sir Knight Captain General: - Reduce the Triangle.

(The Captain General will draw his sword, salute the Commander, who will return the salute by hand. The Captain General will then face the Triangle and command:)

COMM: Reduce the triangle.

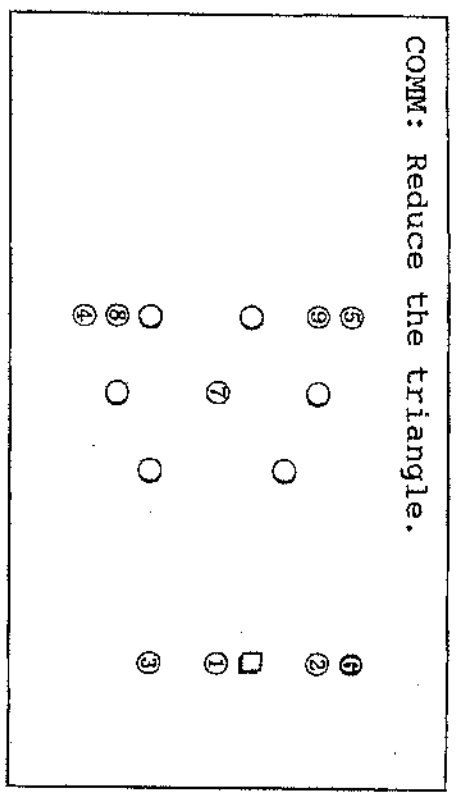

CAP GEN: Sir Knights on the side lines: - Be seated. 1. To form square, 2. First and Third Divisions, 3. Backward Wheel, 4. March.

C.G.: To form square, first and third division . . .

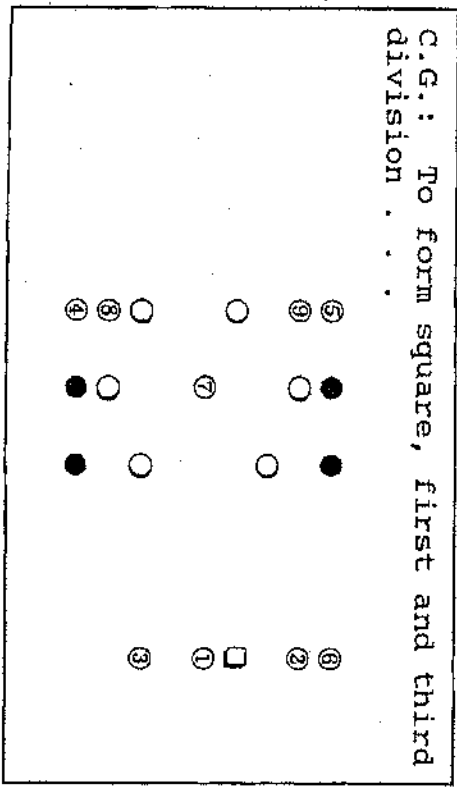

(When the divisions have formed a hollow square, the Captain General will give the command:) 5. Halt.

CAP GEN: Officers: - To the center and front.

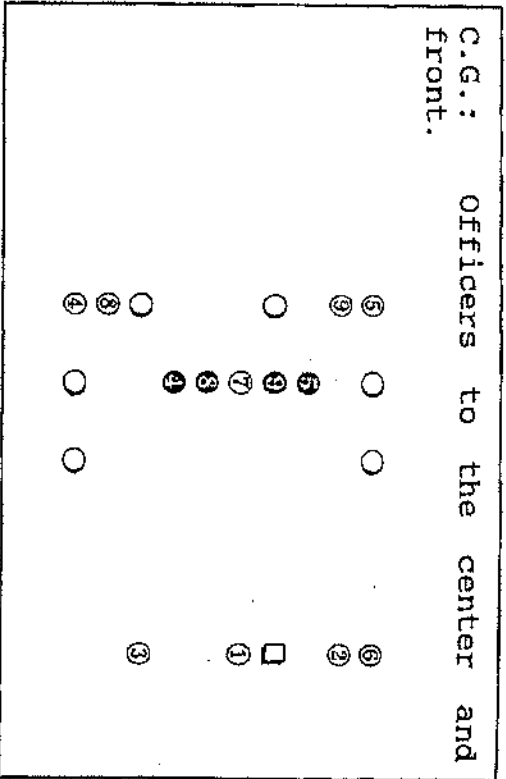

(Officers will step forward, the Sword Bearer and the Senior Warden will take position on the right of the Standard Bearer; the Warden and Junior Warden on the left of the Standard Bearer; they all stand still after taking their positions.)

CAP GEN: March. (The officers will then march to the front, guiding on the Standard Bearer.)

CAP GEN: Halt. (The officers will halt after completing the square, hand salute, which will be acknowledged by all officers on the dais.)

C.G.: March.

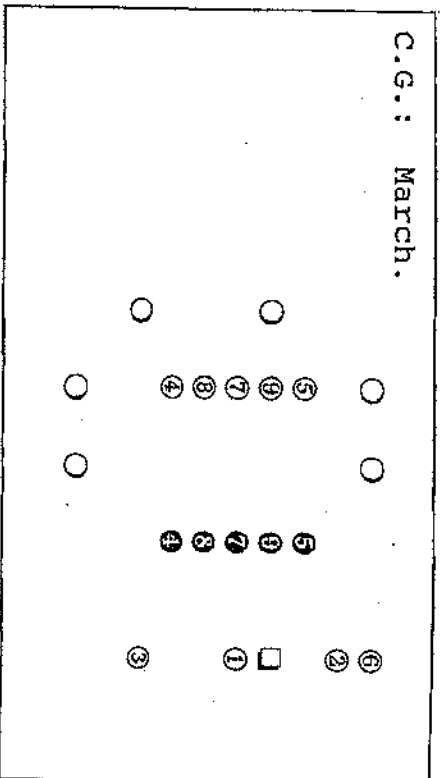

CAP GEN: 1. Form two divisions, 2. Second Division right and left backward wheel, 3. March.

C.G.: Form two divisions . . .

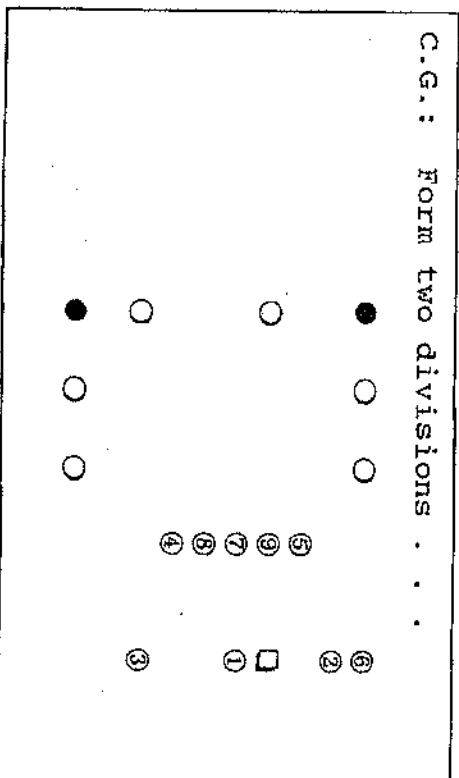

(The Second Division divides in the center. The right half wheels backward to the left and the left half wheels backward to the

right thus forming two parallel lines or divisions.)

CAP GEN: Halt.

CAP GEN: Officers: - 1. About, 2. Face, 3. Commandery, 4. Draw, 5. Swords, 6 Present, 7. Swords, 8. Officers, 9. Post.

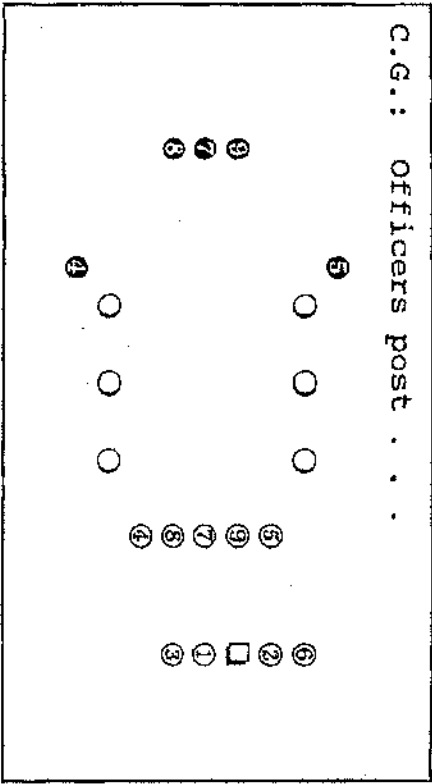

SR WARD: Officers: - 1. Carry, 2. Swords, 3. Forward, 4. March. (As the officers march to their posts, the Senior and Junior Wardens will drop off at their stations, marching around the foot of the lines. The Warder, Standard Bearer, and Sword Bearer will continue to march to the west to their stations where the Sword Bearer will take command.)

SW BEAR: Standard Guard: - 1. Halt, 2. About, 3. Face, 4. Present, 5. Swords. (As the Standard

Guard comes to present swords, the Senior and Junior Wardens will come to salute swords at the same time. When the above is executed, the Captain General will command.)

CAP GEN: 1. Carry, 2. Swords, 3. Return, 4. Swords, 5. About, 6. Face, 7. Be Seated.

CAP GEN: Eminent Commander: - Your orders have been obeyed. (The Captain General will salute the Commander with sword salute, returned by the Commander with his hand. He then returns his sword and is seated.)

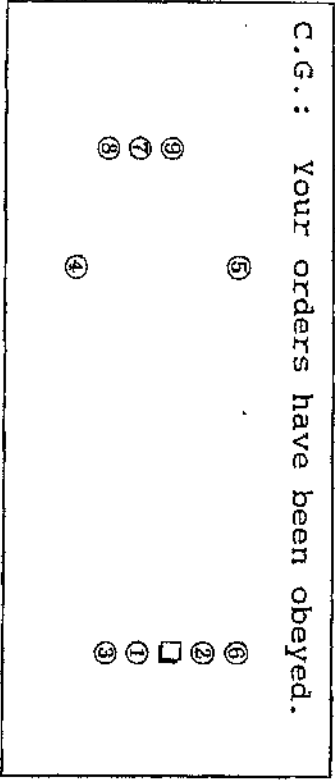

Alternate Triangle

COMM: Sir Knight Captain General: - Form the Triangle preparatory to our devotions.

CAP GEN: Form Triangle: - First and Second Divisions, from the west, backward wheel, 2. March. (On this command the two divisions will wheel backward until the Captain General gives the commands:) 3. Halt. (The two divisions should be far enough apart so that the Standard Guard can march to the bottom of the Triangle.)

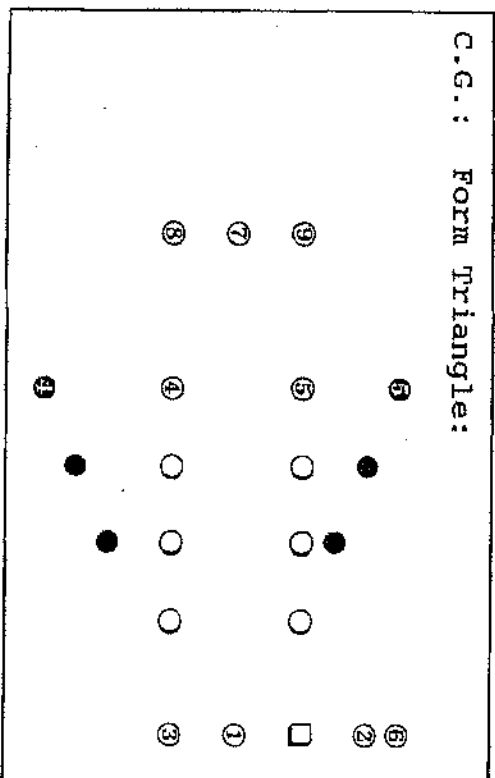

CAP GEN: Standard Guard: - Post.

C.G.: Standard Guard: - Post.

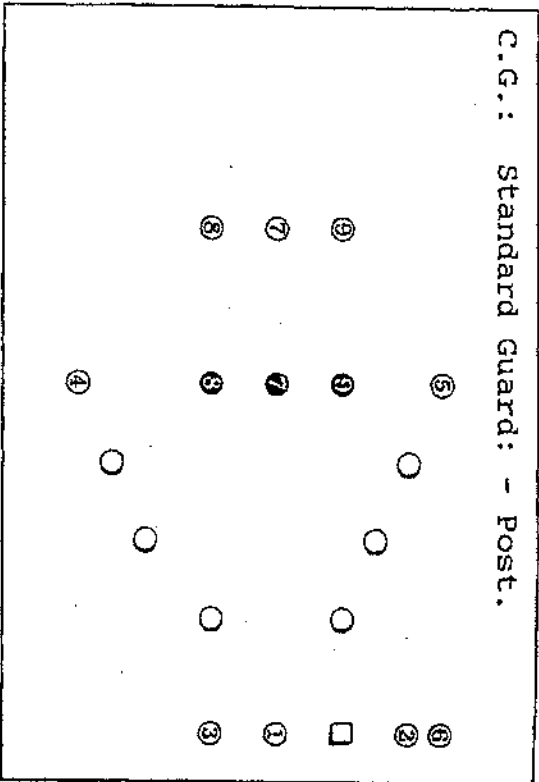

SW BEAR: Standard Guard: - 1. Forward, 2. March

(The Standard Guard will march forward until they are in line with the Senior and Junior Wardens. The Sword Bearer will then give the command to "halt". After the Standard Guard has halted at the bottom of the Triangle, the Captain General will report to the Commander.)

Comm: Sir Knight Generalissimo, Captain General and Excellent Prelate: - Accompany me to the Triangle. (As the dais officers and the Prelate reach the triangle, the Standard Bearer will step forward about two paces into the triangle and ground the Beauceant. The Senior and Junior Wardens will face toward the east.)

COMM: Accompany me to the Triangle.

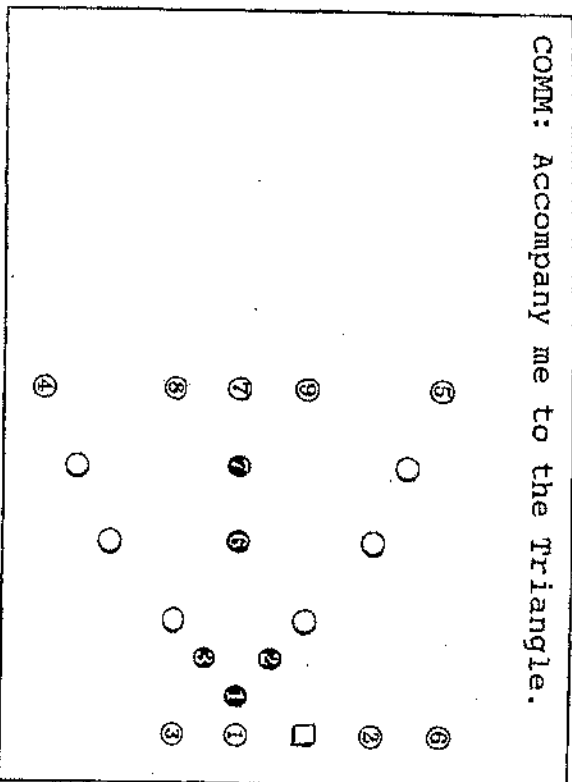

COMM: Sir Knights: - 1. To your devotions, 2. Kneel, 3. Uncover. Excellent Prelate: - Lead our devotions. (All Sir Knights, including the Standard Bearer, will uncover with their left hand and place the chapeau on the right shoulder. The Standard Bearer does not kneel.)

PRELATE: (Gives prayer followed by the Lord's Prayer.)

COMM: Sir Knights: - 1. Recover, 2. Arise (After this command, the dais officers return to their stations stopping in front of the dais waiting until the Prelate reaches his station, They then return to the dais together.)

COMM: Sir Knight Captain General: - Reduce the

Triangle. (The Captain General will draw his sword, sword salute the Commander, who will respond with a hand salute, face the Triangle and commands.)

COMM: Reduce the Triangle.
(Proceed as illustrated for reducing standard triangle.)

CAP GEN: 1. Form Square, 2. First and Second Divisions, 3. Backward wheel, 4. March. (When the square is formed the captain General will command.) 5. Halt.

CAP GEN: Officers: - 1. To the center and front, 2. March. (At the command "march", the officers will step forward, the Sword Bearer and the Senior Warden will take position on the right of the Standard Bearer; the Warden and the Junior Warden on the left of the Standard Bearer; they all stand still after taking their positions until the Captain General orders "march". They will march to the front, guiding on the Standard Bearer.) 4. Halt. (The officers hand salute the officers on the dais which will be returned by all on the dais.)

CAP GEN: Officers: - 1. About, 2. Face, 3. Commandery, 4. Draw, 5. Swords, 6. Present, 7. Swords, 8. Officers, 9. Post.

SR WARD: Officers: - 1. Carry, 2. Swords, 3.

Forward, 4. March, (As the officers march to their posts, the Senior and Junior Wardens will drop off at their stations, marching around the foot of the lines, the Warden, Standard Bearer and Sword Bearer will continue to march to the west to their stations where the Sword Bearer will take command.)

SW BEAR: Standard Guard: - 1. Halt, 2. About, 3. Face, 4. Present, 5. Swords. (As the Standard Guard comes to present swords, the Senior and Junior Wardens will come to salute swords at the same time. When the above is executed, the Captain General will command.)

CAP GEN: 1. Carry, 2. Swords, 3. Return, 4. Swords. (On the command "swords" the Standard Bearer shall return the Beaumont to its stand.) 5. First and Second Division, 6. About, 7. Face, 8. Be seated.

CAP GEN: Eminent Commander: - Your orders have been obeyed. (The Captain General will salute the Commander with a sword salute, returned by the Commander with his hand. He then returns his sword and is seated.)

Rehearsal of Duties

COMM: Sir Knight Captain General: - Call the officers to attention and draw swords.

CAP GEN: Officers: - 1. Attention, 2. Draw, 3. Swords.

COMM: Sir Knight Generalissimo: - Are you a Knight Templar?

GEN: That is my title.

COMM: Where were you created a Knight Templar?

GEN: In a regular and duly constituted Commandery of Knights Templar.

COMM: How many compose such a Commandery?

GEN: There is an Indispensable number, and a Constitutional number.

COMM: What is the Indispensable number?

GEN: Three.

COMM: Under what circumstances may three form and open a Commandery?

GEN: Three Knights Templar, hailing from three separate Commanderies, and acting under a lawful Warrant, may form and open a

Commandery of Knights Templar for the dispatch of business.

COMM: What is the Constitutional number?

GEN: Nine, or more.

COMM: When composed of eleven, who are they?

GEN: The Commander, Generalissimo, Captain General, Senior Warden, Junior Warden, Prelate, Treasurer, Recorder, Standard Bearer, Sword Bearer, and Warden.

COMM: The station of the Warden?

GEN: On the left of the Standard Bearer, and on the left of the Second Division when separately formed.

COMM: Sir Knight Warden: - Your duty?

WARD: To sound the assembly, post the Sentinel, announce the approach and departure of the Commander, and see that the Asylum is duly guarded.

COMM: The station of the Sword Bearer?

WARD: On the right of the Standard Bearer, and on the right of the Second Division when separately formed.

COMM: Sir Knight Sword Bearer: - Your duty?

SW BEAR: To assist in protecting the Banner of our Order.

COMM: The station of the Standard Bearer?

SW BEAR: In the West, and in the center of the Second Division.

COMM: Sir Knight Standard Bearer: - Your duty?

ST BEAR: To display, support, and protect the Banner of our Order.

COMM: Why are you stationed in the West?

ST BEAR: That the brilliant rays of the rising Sun, shedding lustre upon the Banner of our Order, may animate and encourage all valiant and magnanimous Knights, and dismay and confound their enemies.

COMM: The station of the Recorder?

ST BEAR: On the left, and in front of the Captain General.

COMM: Sir Knight Recorder: - Your duty?

REC: Faithfully to record the transactions of the Commandery, collect the revenue and pay it over to the Treasurer.

COMM: The station of the Treasurer?

REC: On the right, and in front of the Generalissimo.

COMM: Sir Knight Treasurer: - Your duty?

TR: To receive in charge all the funds and property of the Commandery, pay all orders drawn on the Treasury, and render a true account when required.

COMM: The station of the Prelate?

TR: On the right of the Generalissimo.

COMM: Excellent Prelate: - Your duty?

PRELATE: To minister at the Altar, and offer up prayers to Deity.

COMM: The station of the Junior Warden?

PRELATE: At the Northwest angle of the Triangle, on the right or in front of the Third Division when separately formed, and on the left of the Commandery when in line.

COMM: Sir Knight Junior Warden: - Your duty?

JR WARD: To attend poor and weary Pilgrims traveling from afar, accompany them on their journey, and in due time recommend them to the Commander.

COMM: The station of the Senior Warden?

JR WARD: At the Southwest angle of the Triangle, on the right or in front of the First Division when separately formed, and on the right of the Commandery when in line.

COMM: Sir Knight Senior Warden: - Your duty?

SR WARD: To attend Pilgrim Warriors; comfort and support Pilgrim Penitents; and after due, trial introduce them into the Asylum.

COMM: The station of the Captain General?

SR WARD: On the left of the Commander.

COMM: Sir Knight Captain General: - Your duty?

CAP GEN: To see that due preparation is made for the conclaves of the Commandery, that the Asylum is in suitable array for the introduction of candidates and the dispatch of business, to execute the orders of the Commander, and in his absence and that of the Generalissimo to preside.

COMM: The station of the Generalissimo?

CAP GEN: On the right of the Commander.

COMM: Sir Knight Generalissimo: - Your duty?

GEN: To assist the Commander in the duties of his

office, and in his absence to preside.

COMM: The station of the Commander?

GEN: In the East, or at the head of the
Commandery.

COMM: His duty?

GEN: To distribute alms to poor and weary
pilgrims traveling from afar, feed the
hungry, clothe the naked, and bind up the
wounds of the afflicted, to inculcate the
duties of charity and hospitality, and govern
the Commandery with justice and
moderation.

COMM: Sir Knight Generalissimo: - It is my order
that _____ Commandery, No. _____, be
now opened for the dispatch of such
business as may regularly come before it,
requiring all Knights present to govern
themselves according to the sublime
principles of this magnificent Order. This
you will communicate to the Captain
General and he to the Sir Knights. (The
Commander salutes the Generalissimo, thus
releasing him to perform that order and the
Generalissimo returns the Commander's
Salute.)

GEN: Sir Knight Captain General: (Captain
General sword salutes the Generalissimo) It
is the order of the Commander that _____

Commandery No. _____ be now opened for
the dispatch of such business as may
regularly come before it, requiring all
Knights present to govern themselves
according to the sublime principles of this
magnificent Order. This you will
communicate to the Sir Knights. (The
Generalissimo will salute the Captain
General who will return the salute and then
call up the Commandery.)

CAP GEN:

Sir Knights: - 1. Attention, 2. Draw, 3.
Swords. It is the order of the Commander
that _____ Commandery No. _____ be now
opened for the dispatch of such business as
may regularly come before it. Take due
notice and govern yourselves according to
the sublime principles of this magnificent
Order. Present swords. (The Captain
General then turns to the Generalissimo,
sword salutes and reports:) Sir Knight
Generalissimo: - The order of the
Commander has been obeyed.

GEN:

(The Generalissimo then turns to the
Commander, salutes and reports.) Eminent
Commander: - Your order has been obeyed.

COMM:

(Rises and draws sword.)

I now declare _____ Commandery No.
_____ opened in due form. Sir Knights, carry
swords. Sir Knight Warder: - Inform the
Sentinel and direct him to guard accordingly.
(Warder closes the door and gives knocks:

xxx xxx xxx x. Answered by the Sentinel.
Warder returns to his station and reports.)

WARDER: Eminent Commander, your order has been obeyed.

COMM: Sir Knights: 1. Return, 2. Swords, 3. Be seated.

END OF FULL FORM OPENING

TO CLOSE THE COMMANDERY

COMM: S. K. Captain General: I am about to close this Commandery. See that the Sentinel is informed, and that he guard accordingly.

CAP. GEN.: S. K. Warder: Inform the Sentinel that the Commander is about to close this Commandery, and direct him to guard accordingly.

WARDER: (Informs Sentinel, Knocks, and Reports from station.) S. K. Captain General: The Sentinel is informed.

CAP. GEN.: Eminent Commander: Your order has been obeyed.
COMM: Commandery: Attention. Uncover. Ex. Prelate: Lead our devotions.

PRAYER

COMM: Sir Knights: Recover.
COMM: I now declare _____ No. _____ duly closed.

COMM: S. K. Warder: Inform the Sentinel.
WARDER: (Opens door and says)

S. K. Sentinel: The Commandery is closed.

WARDER: (Returns to station and reports.)
COMM: Eminent Commander: The Sentinel is informed.

Sir Knights: You are dismissed.